

| | |
|----------|--------------|
| SPEC No. | CC24Z001 |
| ISSUE : | Feb. 14 2013 |

To : _____

PRELIMINARY

SPECIFICATIONS

Product Type 1/1.8-type Progressive Scan Color CCD Area Sensor with 2106k Pixels

Model No R J 3 1 N 3 A A 0 D T

※ This specifications contains 43 pages including the cover and appendix.
If you have any objections, please contact us before issuing purchasing order.

CUSTOMERS ACCEPTANCE

DATE : _____

BY : _____

PRESENTED

BY : J. Nakai

J.NAKAI

Dept. General Manager

REVIEWED BY :

PREPARED BY :

J. Konishi

I. Baba



Development Dept. II
Sensing Device Division
Electronic Components And Devices Group
SHARP CORPORATION

- Handle this document carefully for it contains material protected by international copyright law. Any reproduction, full or in part, of this material is prohibited without the express written permission of the company.

- When using the products covered herein, please observe the conditions written herein and the precautions outlined in the following paragraphs. In no event shall the company be liable for any damages resulting from failure to strictly adhere to these conditions and precautions.
 - (1) Please do verify the validity of this part after assembling it in customer's products, when customer wants to make catalogue and instruction manual based on the specification sheet of this part.

 - (2) The products covered herein are designed and manufactured for the following application areas. When using the products covered herein for the equipment listed in Paragraph (3), even for the following application areas, be sure to observe the precautions given in Paragraph (3). Never use the products for the equipment listed in Paragraph (4).

Office electronics

 - Instrumentation and measuring equipment
 - Machine tools
 - Audiovisual equipment
 - Home appliance
 - Communication equipment other than for trunk lines

 - (3) Those contemplating using the products covered herein for the following equipment which demands high reliability, should first contact a sales representative of the company and then accept responsibility for incorporating into the design fail-safe operation, redundancy, and other appropriate measures for ensuring reliability and safety of the equipment and the overall system.
 - Control and safety devices for airplanes, trains, automobiles, and other transportation equipment
 - Mainframe computers
 - Traffic control systems
 - Gas leak detectors and automatic cutoff devices
 - Rescue and security equipment
 - Other safety devices and safety equipment, etc

 - (4) Do not use the products covered herein for the following equipment which demands extremely high performance in terms of functionality, reliability, or accuracy.
 - Aerospace equipment
 - Communications equipment for trunk lines
 - Control equipment for the nuclear power industry
 - Medical equipment related to life support, etc.

 - (5) Please direct all queries and comments regarding the interpretation of the above three Paragraphs to a sales representative of the company.

- Please direct all queries and regarding the products covered herein to a sales representative of the company.

CONTENTS

| | | |
|-----|---|----|
| 1 | DESCRIPTION | 2 |
| 1.1 | Features | |
| 1.2 | Applications | |
| 2 | ARRANGEMENT OF PIXELS AND COLOR FILTERS | 3 |
| 3 | PIN CONFIGURATION | 4 |
| 4 | ABSOLUTE MAXIMUM RATINGS | 4 |
| 4.1 | CCD, VDr Power sequence | |
| 5 | RECOMMENDED OPERATING CONDITIONS | 8 |
| 6 | CHARACTERISTICS | 9 |
| 7 | DRIVE TIMING CHART | 11 |
| 8 | EXAMPLE OF STANDARD OPERATING CIRCUIT | 36 |
| 9 | PECIFICATION FOR BLEMISH | 37 |
| 10 | PRECAUTIONS | 39 |
| 9.1 | Package Breakage | |
| 9.2 | Electrostatic Damage | |
| 9.3 | Dust and Contamination | |
| 9.4 | Other | |
| 11 | PACKAGE OUTLINES AND PACKING SPECIFICATIONS | 41 |

1 DESCRIPTION

The RJ31N3AA0DT is a 1/1.8-type solid-state image sensor that consists of PN photo-diodes and CCDs (charge-coupled devices). With approximately 2,106,000 pixels, the sensor provides a high resolution stable color image.

1.1 Features

- 1) Optical size : 8.979 mm (Aspect ratio 4:3)

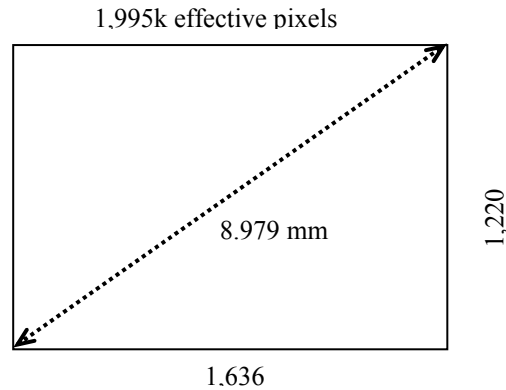

- 2) Progressive scan format
 3) Square pixel
 4) Number of total pixels : Horizontal 1688 × vertical 1248
 Number of image pixels : Horizontal 1644 × vertical 1236
 Number of effective pixels : Horizontal 1636 × vertical 1220
 Pixel pitch : Horizontal 4.4 μm × vertical 4.4 μm
 Number of optical black pixels : Horizontal ; 12 front and 32 rear
 : Vertical ; 10 front and 2 rear
 Number of dummy bits : Horizontal ; 28, Vertical ; 1
 5) R, G and B primary color mosaic filters
 6) Supports monitoring mode
 7) Built-in overflow drain voltage output circuit, and reset gate voltage circuit
 8) Variable electronic shutter
 9) Low fixed pattern noise and lag
 10) No burn-in and no image distortion
 11) Blooming suppression structure
 12) Built-in output amplifier
 13) N-type silicon substrate, N-MOS process,
 Not designed or rated as radiation hardened
 14) Global shutter

1.2 Applications

- 1) Electronic still cameras, video capturing devices for PCs, etc
 2) Pattern recognition

※ The circuit diagram and others included in this specifications are intended for use to explain typical application examples. Therefore, we take no responsibility for any problem as may occur due to the use of the included circuit and for any problem with industrial proprietary rights or other rights.

3 PIN CONFIGURATION (TOP VIEW)

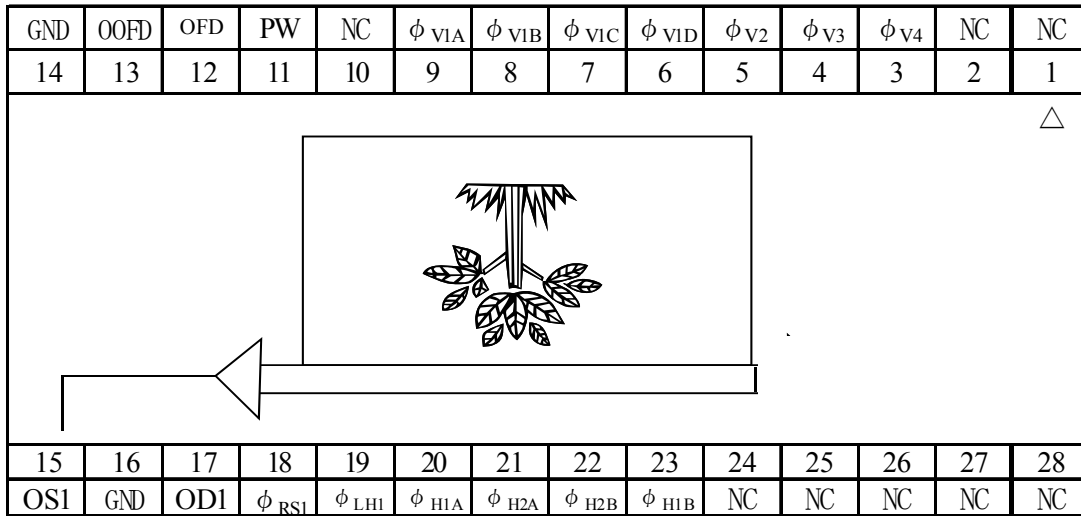

| Symbol | Pin name |
|---|---------------------------------|
| OD | Output transistor drain |
| OS | Output signals |
| ϕ_{RS} | Reset transistor clock |
| $\phi_{V1A}, \phi_{V1B}, \phi_{V1C}, \phi_{V1D}, \phi_{V2}, \phi_{V3}, \phi_{V4}$ | Vertical shift register clock |
| $\phi_{LH1}, \phi_{H1A}, \phi_{H2A}, \phi_{H1B}, \phi_{H2B}$ | Horizontal shift register clock |
| OFD | Overflow drain |
| OOFD | Output overflow drain |
| PW | P_well |
| GND | Ground |

4 ABSOLUTE MAXIMUM RATINGS

($T_A=25^\circ\text{C}$)

| Parameter | Symbol | Ratings | Unit |
|--|---------------------------|--------------------------|------------------|
| Output transistor drain voltage | V_{OD} | 0 to +15.4 | V |
| Overflow drain voltage | V_{OFD} | Internal output (Note 1) | |
| Reset gate clock voltage | $V_{\phi_{RS}}$ | Internal output (Note 2) | |
| Vertical shift register clock voltage | V_{ϕ_V} | $V_{PW} + 15.4$ | V |
| Horizontal shift register clock voltage | V_{ϕ_H} | -0.3 to +5.1 | V |
| Voltage difference between P_well and vertical clock | $V_{PW} - V_{\phi_V}$ | -23.8 to +0 | V |
| Voltage difference between vertical clocks | $V_{\phi_V} - V_{\phi_V}$ | 0 to +9.9 (Note 3) | V |
| Storage temperature | T_{STG} | -40 to +80 | $^\circ\text{C}$ |
| Ambient operating temperature | T_{OPR} | -20 to +70 | $^\circ\text{C}$ |

(Note 1) Do not connect to DC voltage directly. When OFD is connected to GND, connect V_{OD} to GND. Overflow drain clock is applied below 22.5 Vp-p.

(Note 2) Do not connect to DC voltage directly. When ϕ_{RS} is connected to GND, connect V_{OD} to GND. Reset gate clock is applied below 5.1 Vp-p.

(Note 3) When clock width is below 10 μs , and clock duty factor is below 0.1 %, voltage difference between adjoining vertical clocks are guaranteed up to 15.4 V.

Do not change all ϕ_V during 0.5 μs before rising edge of $V_{\phi_{VH}}$ pulse and after falling edge of $V_{\phi_{VH}}$ pulse.

Do not change directly into $V_{\phi_{VL}} \rightarrow V_{\phi_{VH}}$ or $V_{\phi_{VH}} \rightarrow V_{\phi_{VL}}$.

4.1 CCD, VDr Power sequence

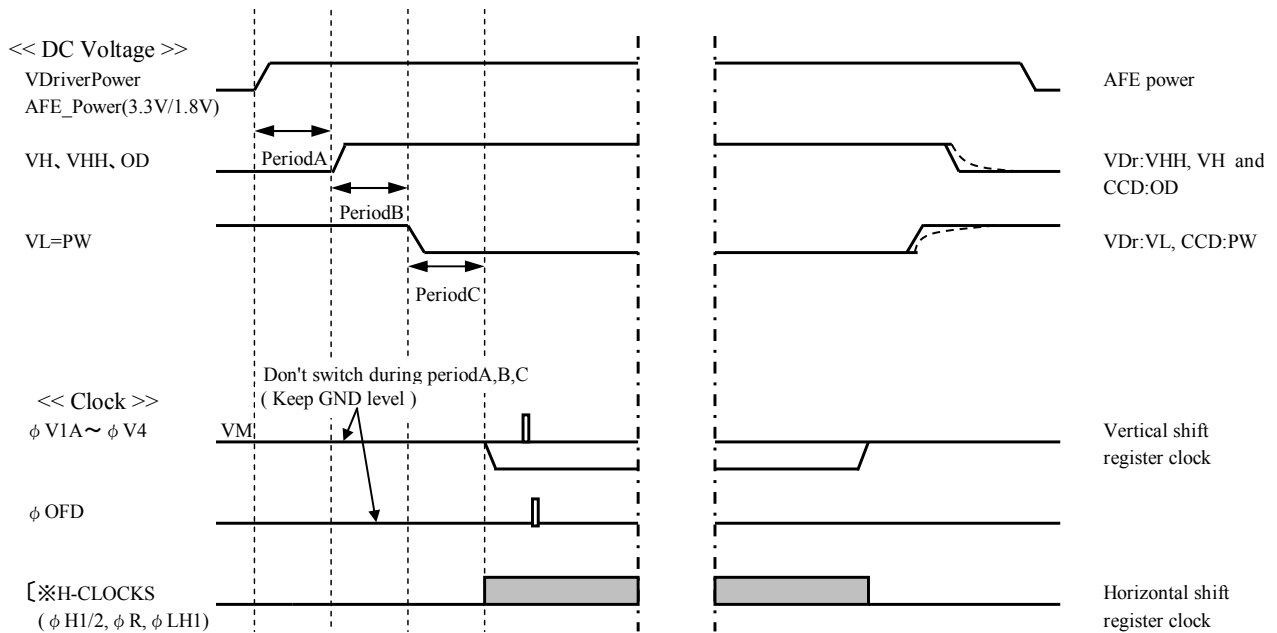

○Power ON sequence

Turn on power in order of VDD→VH(=VHH=OD)→VL(=PW) and after that apply the clocks.

All ϕV pin of CCD should be VM[Intermediate(0V)]level during period A, B, C.

ϕOFD pin of CCD should be Low level during period A, B, C.

Period A : Turn on VH with the condition that all ϕV pulse is VM[Intermediate(0V)]level.

Period B : Turn on VL(=PW) after VH(=VHH=OD) voltage reach to higher than 90% of its typical voltage.

Period C : Start ϕV clocks after VL(=PW) voltage reach to lower than 90% of its typical voltage.

○Power OFF sequence

Turn off power in reverse order of Power ON. At Power OFF sequence, it is not problem any power reach to 0V earlier (caused by difference of time constant of decoupling capacitor).

But in case of turn on again, turn on should be done in order shown above after all voltage of power reach less than 10% of its typical value.

(AFE power < AFE power * 0.1 & VH < VH * 0.1 & VL > VL * 0.1)

○Restriction matter of ϕV and ϕOFD switching

1) Please turn on power in condition that all ϕV pulse is VM[Intermediate(0V)]level.

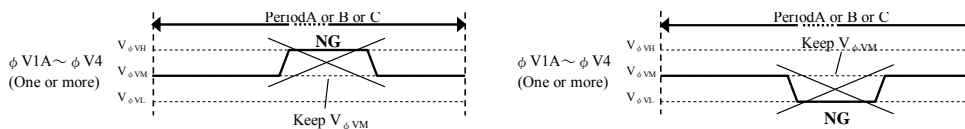

2) Please turn on power in condition that ϕOFD pulse is Low level.

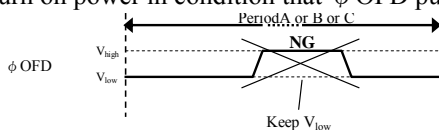

3) Please avoid same time (<50ns) switching of ϕV and ϕOFD .

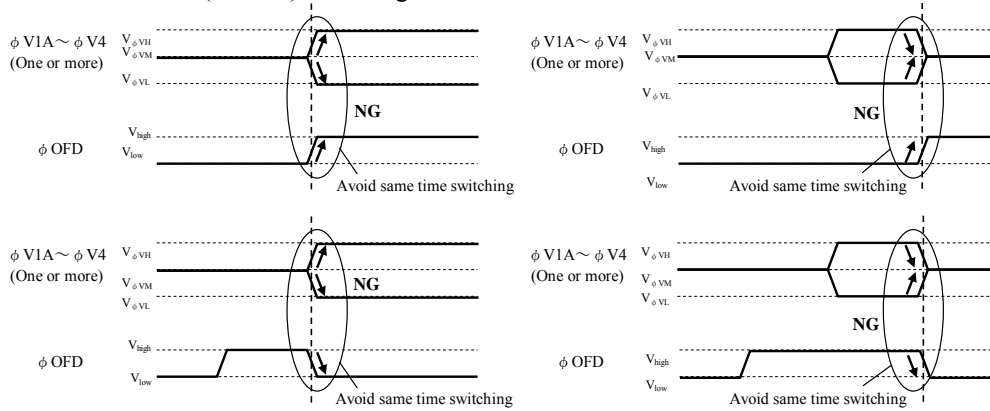

4) Please avoid switching of ϕV during period that ϕOFD is High.

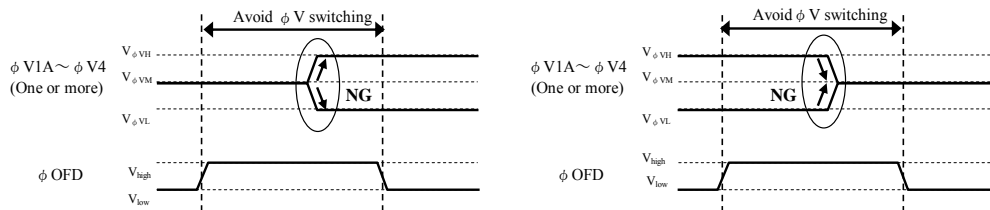

5) Start or stop ΦV switching at the arbitrary point on timing chart of CCD spec. except following period. ϕV clock should not start or stop at,

5-1) Exposure period of long time exposure (all $\phi V = L$)

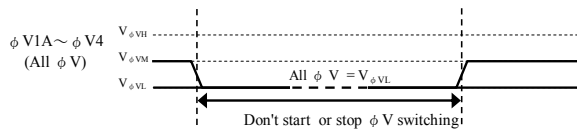

5-2) During period that $\phi OFD = High$.

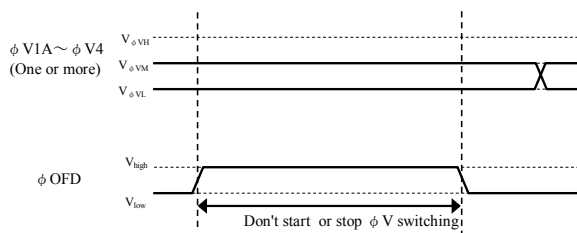

5-3) During period that $\phi V = High$.

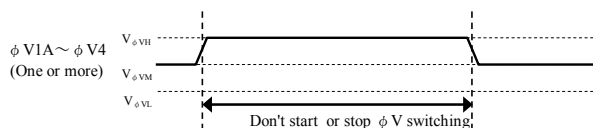

6) Only in case of clock width is below 10 μ s and clock duty factor is below 0.1%, voltage difference between adjoining vertical clocks are guaranteed up to 15.4V.
Only if all the following conditions are satisfied, VH pulse is allowed.

6-1) Width is 10 μ s or less.

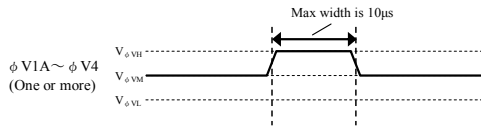

6-2) Clock duty factor is 0.1% or less.

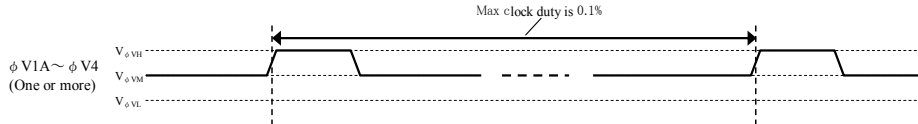

6-3) Adjoining gate level is 0V.

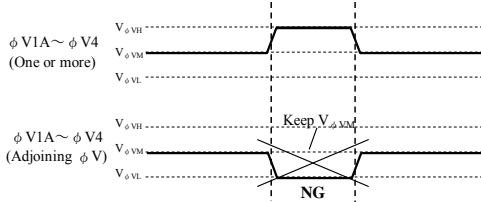

Adjoining vertical clock gate: See Table.1

7) Don't change all ϕ V during 0.5 μ s before rising edge of $V \phi VH$ pulse and after falling edge of $V \phi VH$ pulse.

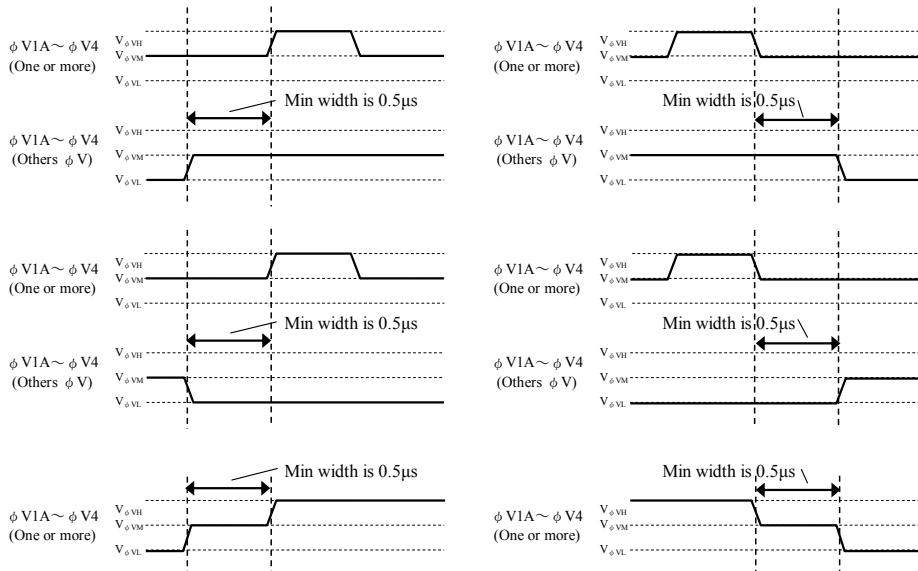

8) Don't change ϕ V directly into $V \phi VL \rightarrow V \phi VH$ or $V \phi VH \rightarrow V \phi VL$.

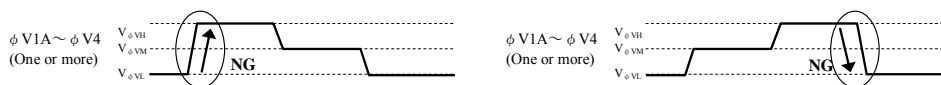

9) Please change mode follow timing chart in CCD spec.

* This sequence explanation specify at Sharp CCD pin. Please check with AFE vender about sequence of AFE.

| | | Adjoining pin | | | | | | |
|--------|-----|---------------|-----|-----|-----|----|----|----|
| | | V1A | V1B | V1C | V1D | V2 | V3 | V4 |
| Φ Vpin | V1A | | | | | ○ | | ○ |
| | V1B | | | | | ○ | | ○ |
| | V1C | | | | | ○ | | ○ |
| | V1D | | | | | ○ | | ○ |
| | V2 | ○ | ○ | ○ | ○ | | ○ | |
| | V3 | | | | | ○ | | ○ |
| | V4 | ○ | ○ | ○ | ○ | | ○ | |

Table.1 Information for adjoining Vertical clock gate pin (Φ Vpin)

5 RECOMMENDED OPERATING CONDITIONS

| Parameter | | Symbol | Min. | Typ. | Max. | Unit |
|--|--------------------|---|-------|-------|---------------|------|
| Ambient operating temperature | | T_{OPR} | | 25.0 | | °C |
| Output transistor drain voltage | | V_{OD} | 13.1 | 13.5 | 13.9 | V |
| Overflow drain clock | p-p level (Note 1) | $V_{\phi OFD}$ | 19.3 | 20.0 | 20.7 | V |
| Ground | | GND | | 0.0 | | V |
| P_well voltage (Note 2) | | V_{PW} | -6.8 | | $V_{\phi VL}$ | V |
| Vertical shift register clock | LOW level | $V_{\phi V1AL}, V_{\phi V1BL},$ $V_{\phi V1CL}, V_{\phi V1DL},$ $V_{\phi V2L}, V_{\phi V3L}, V_{\phi V4L},$ | -6.8 | -6.5 | -6.2 | V |
| | INTERMEDIATE level | $V_{\phi V1AL}, V_{\phi V1BL},$ $V_{\phi V1CL}, V_{\phi V1DL},$ $V_{\phi V2L}, V_{\phi V3L}, V_{\phi V4L},$ | | 0.0 | | V |
| | HIGH level | $V_{\phi V1AH}, V_{\phi V1BH},$ $V_{\phi V1CH}, V_{\phi V1DH},$ | 13.1 | 13.5 | 13.9 | V |
| Horizontal shift register clock | LOW level | $V_{\phi LH1L},$ $V_{\phi H1AL}, V_{\phi H2AL},$ $V_{\phi H1BL}, V_{\phi H2BL}$ | -0.05 | 0.0 | 0.05 | V |
| | HIGH level | $V_{\phi LH1H},$ $V_{\phi H1AH}, V_{\phi H2AH},$ $V_{\phi H1BH}, V_{\phi H2BH}$ | 3.15 | | 3.6 | V |
| Reset gate clock | p-p level (Note 1) | $V_{\phi RS}$ | 3.15 | | 3.6 | V |
| Vertical shift register clock frequency (Note 3) | | $f_{\phi V1A}, f_{\phi V1B},$ $f_{\phi V1C}, f_{\phi V1D},$ $f_{\phi V2}, f_{\phi V3}, f_{\phi V4}$ | | 18.75 | | KHz |
| Horizontal shift register clock frequency | | $f_{LH1},$ $f_{H1A}, f_{H2A}, f_{H1B}, f_{H2B}$ | | 36.0 | | MHz |
| Reset gate clock frequency | | $f_{\phi RS}$ | | 36.0 | | MHz |

(Note 1) Use the circuit parameter indicated in “7 EXAMPLE OF STANDARD OPERATING CIRCUIT” , and do not connect to DC voltage directly.

(Note 2) V_{PW} is set below $V_{\phi VL}$ that is low level of vertical shift register clock, or is used with the same power supply that is connected to V_L of V driver IC.

(Note 3) At frame accumulation mode.

※ To apply power, first connect GND and then turn on V_{OD} . After turning on V_{OD} , turn on V_{PW} first and then turn on other powers and pulses.

Do not connect the device to or disconnect it from the plug socket while power is being applied.

6 CHARACTERISTICS (Drive method : 1/30s frame accumulation)

T_A : +25°C, but +60°C for parameter No.4 and No.5.

Operating conditions : the typical values specified in “5 RECOMMENDED OPERATING CONDITIONS”.

Color temperature of light source : 3200K, IR cut-off filter (CM-500,1 mm) is used.

| No. | Parameter | Symbol | Note | Minimum | Typical | Maximum | Unit |
|-----|---------------------------------|-------------------|------|---------|---------|---------|------|
| 1 | Standard output voltage | V _O | 1 | | 150 | | mV |
| 2 | Photo response non-uniformity | PRNU | 2 | | | 10 | % |
| 3 | Saturation output voltage | V _{SAT} | 3 | TBD | | | mV |
| 4 | Dark output voltage | V _{DARK} | 4 | | 0.5 | 3.0 | mV |
| 5 | Dark signal non-uniformity | DSNU | 5 | | 0.5 | 2.0 | mV |
| 6 | Sensitivity (Green channel) | R (G) | 6 | | 830 | | mV |
| 7 | Smear ratio | SMR | 7 | | -115 | | dB |
| 8 | Image lag | AI | 8 | | | 1.0 | % |
| 9 | Blooming suppression ratio | ABL | 9 | 1000 | | | |
| 10 | Output transistor drain current | I _{OD} | | | 12.0 | | mA |

【 Notes 】

- 1 The average output voltage of G signal under the uniform illumination. The standard exposure conditions are defined as when V_O is 150 mV.
- 2 The image area is divided into 10 × 10 segments under the standard exposure conditions. Each segment's voltage is the average output voltage of all pixels within the segment. PRNU is defined by (V_{max} - V_{min}) / V_O, where V_{max} and V_{min} are the maximum and minimum values of each segment's voltage respectively.
- 3 The image area is divided into 10 × 10 segments. Each segment's voltage is the average output voltages of all pixels within the segment. V_{sat} is the minimum segment's voltage under 10 times exposure of the standard exposure conditions.
- 4 The average output voltage under non-exposure conditions.
- 5 The image area is divided into 10 × 10 segments under non-exposure conditions. DSNU is defined by (V_{dmax} - V_{dmin}), where V_{dmax} and V_{dmin} are the maximum and minimum values of each segment's voltage respectively.
- 6 The average output voltage of G signal when a 1000 lux light source with a 90 % reflector is imaged by a lens of F4, f50 mm.
- 7 The sensor is exposed only in the central area of V/10 square with a lens at F4, where V is the vertical image size. SMR is defined by the ratio of the output voltage detected during the vertical blanking period to the maximum output voltage in the V/10 square.
- 8 The sensor is exposed at the exposure level corresponding to the standard conditions. AI is defined by the ratio of the output voltage measured at the 1st field during the non-exposure period to the standard output voltage.
- 9 The sensor is exposed only in the central area of V/10 square, where V is the vertical image size. ABL is defined by the ratio of the exposure at the standard conditions to the exposure at a point where blooming is observed.

【 Comment 】

Within the recommended operating conditions of V_{OD}, V_{OFD} of the internal output satisfies with ABL and V_{SAT}.

7 DRIVE TIMING CHART

Vertical transfer timing [All-pixel readout mode] fck=36MHz 14.985fps

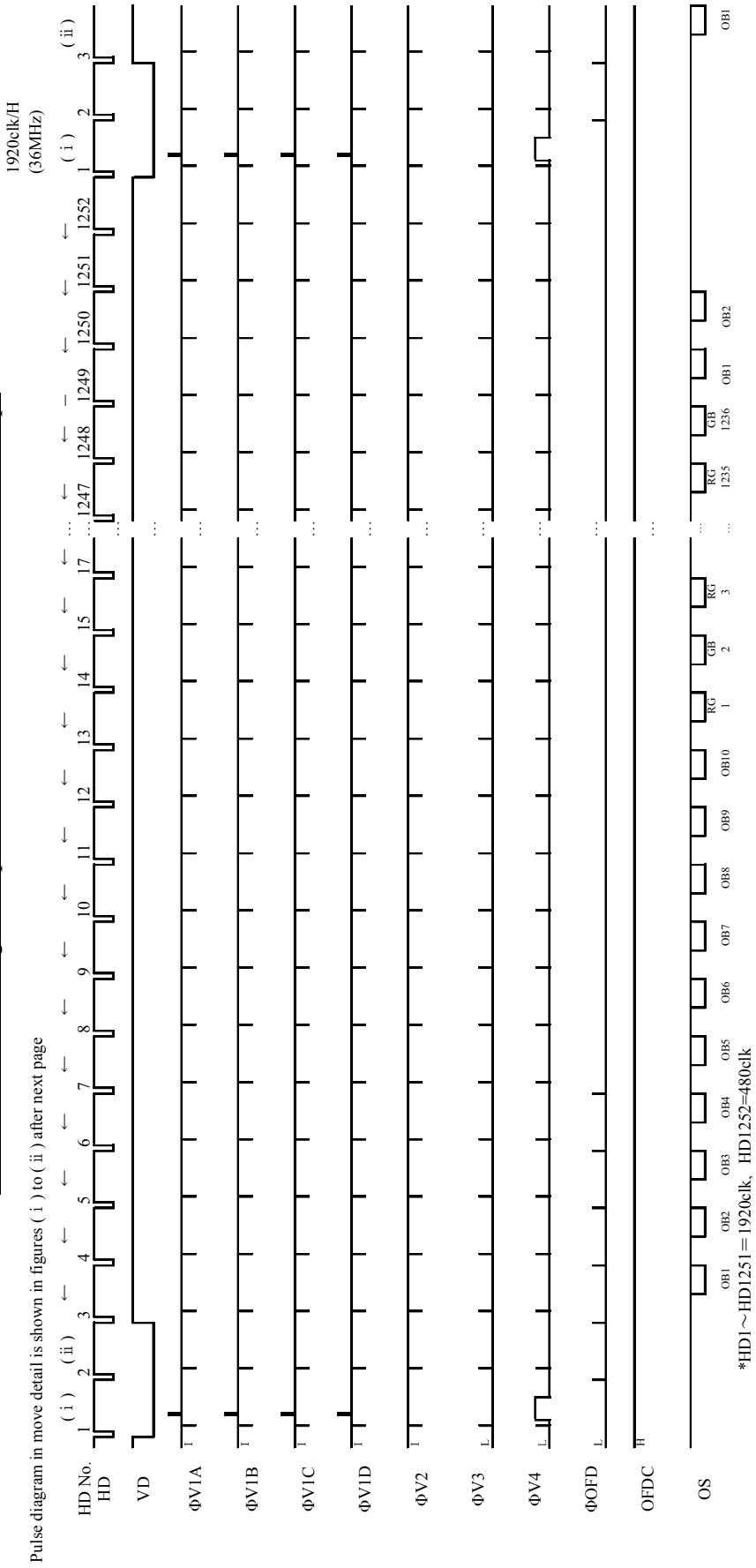

Readout timing [All-pixel readout mode] fck=36MHz 14.985fps (ii)

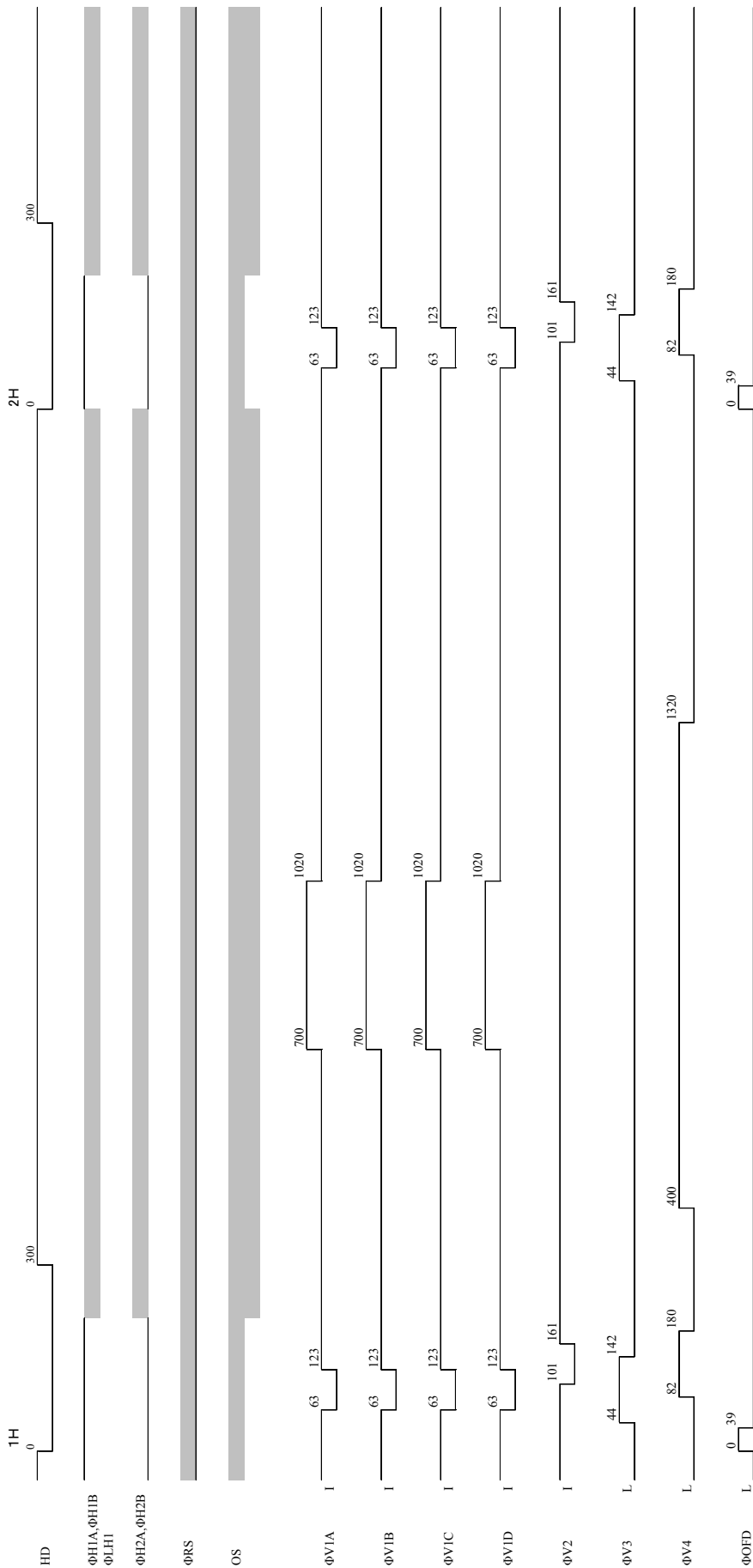

* Keep over the periods indicated in this timing chart when vertical transfer clock pulse is overlapping.

Horizontal transfer timing 【 All-pixel readout mode 】 fclk=36MHz 14.985fps (ii)

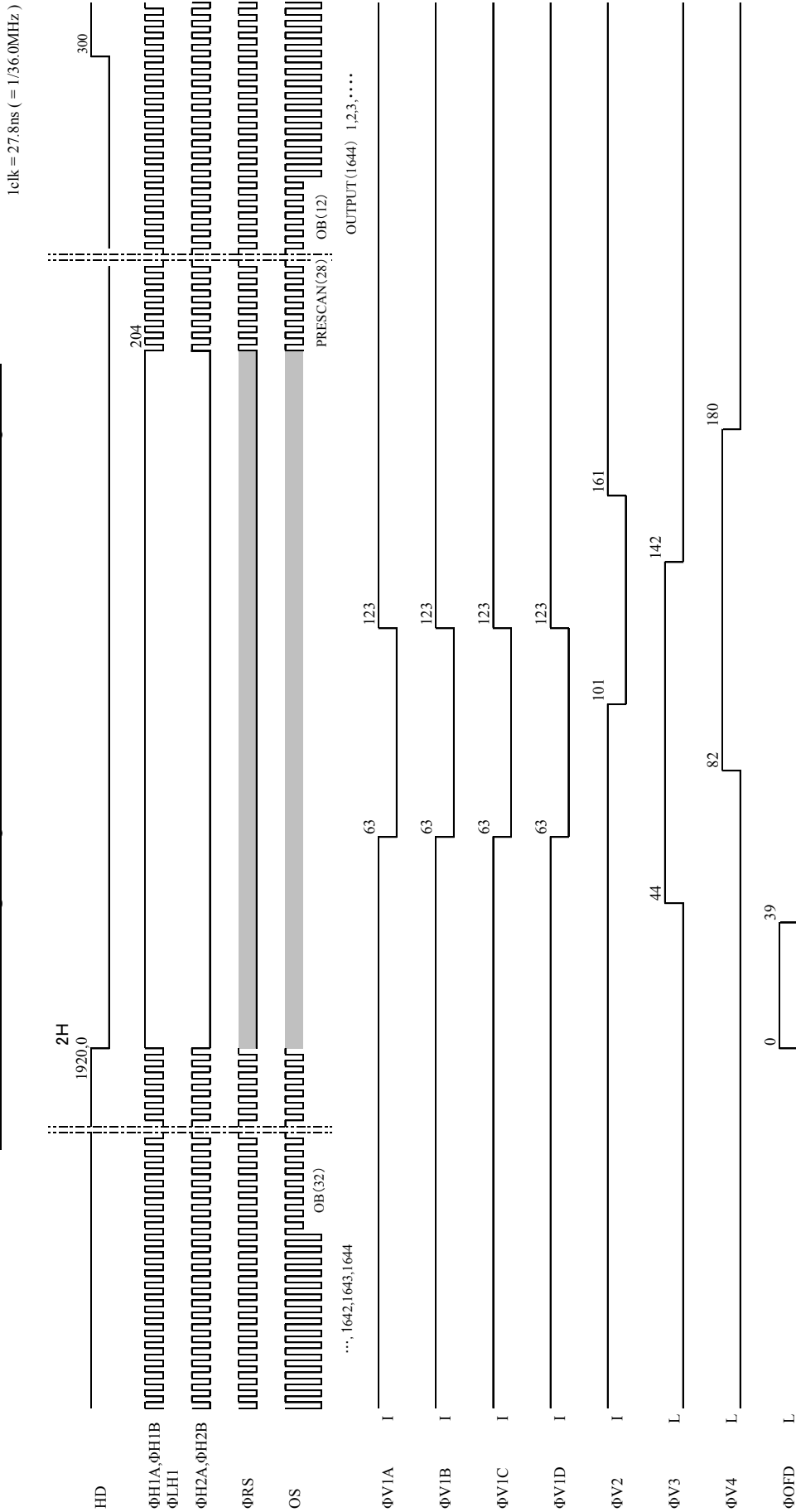

* Keep over the periods indicated in this timing chart when vertical transfer clock pulse is overlapping.

Vertical transfer timing [Progressive scan mode [Center 568 line] fck=36MHz 29.97fps]

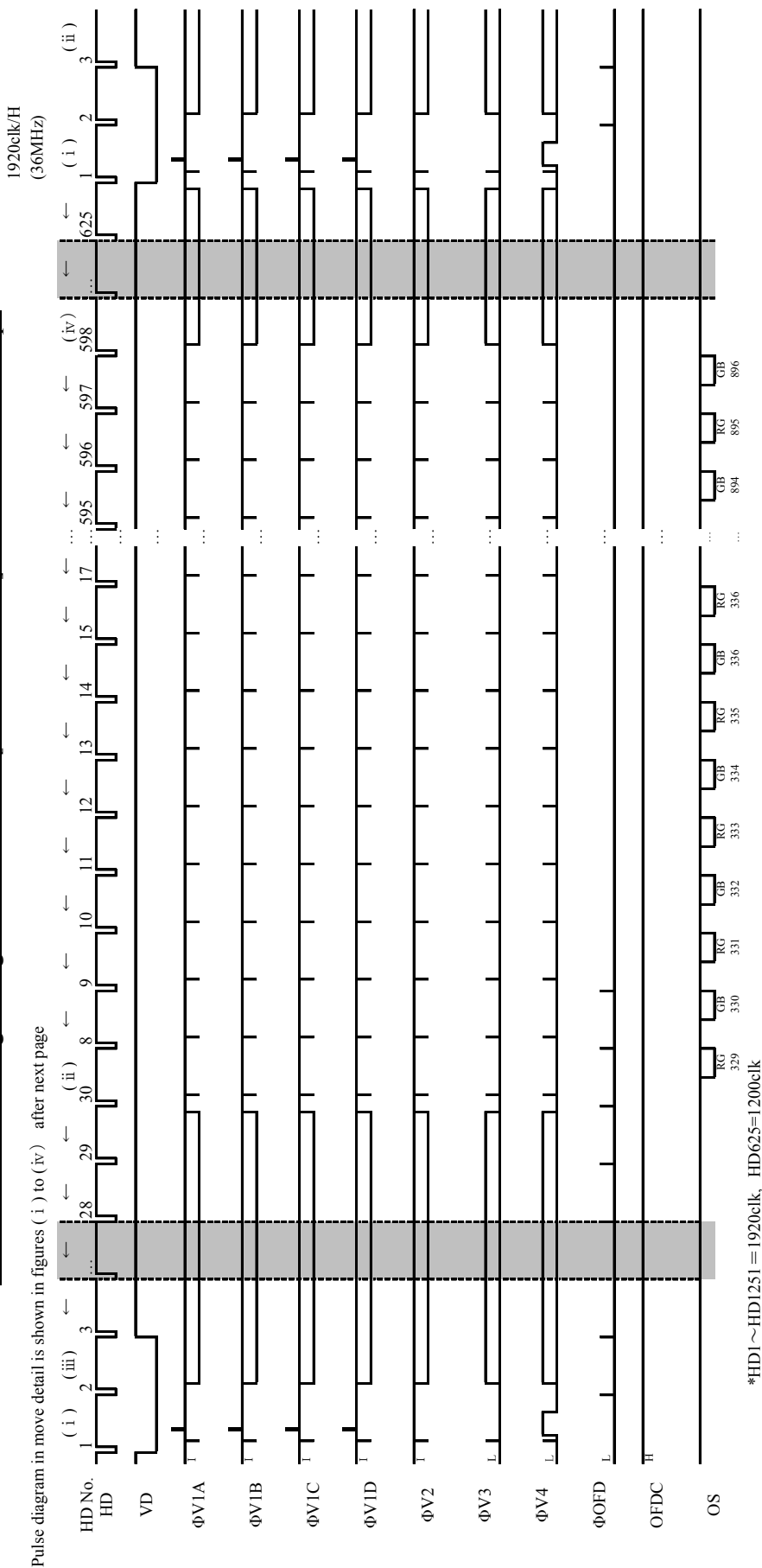

Readout timing [Progressive scan mode [Center 568 line] fck=36MHz 29.97fps (i)]

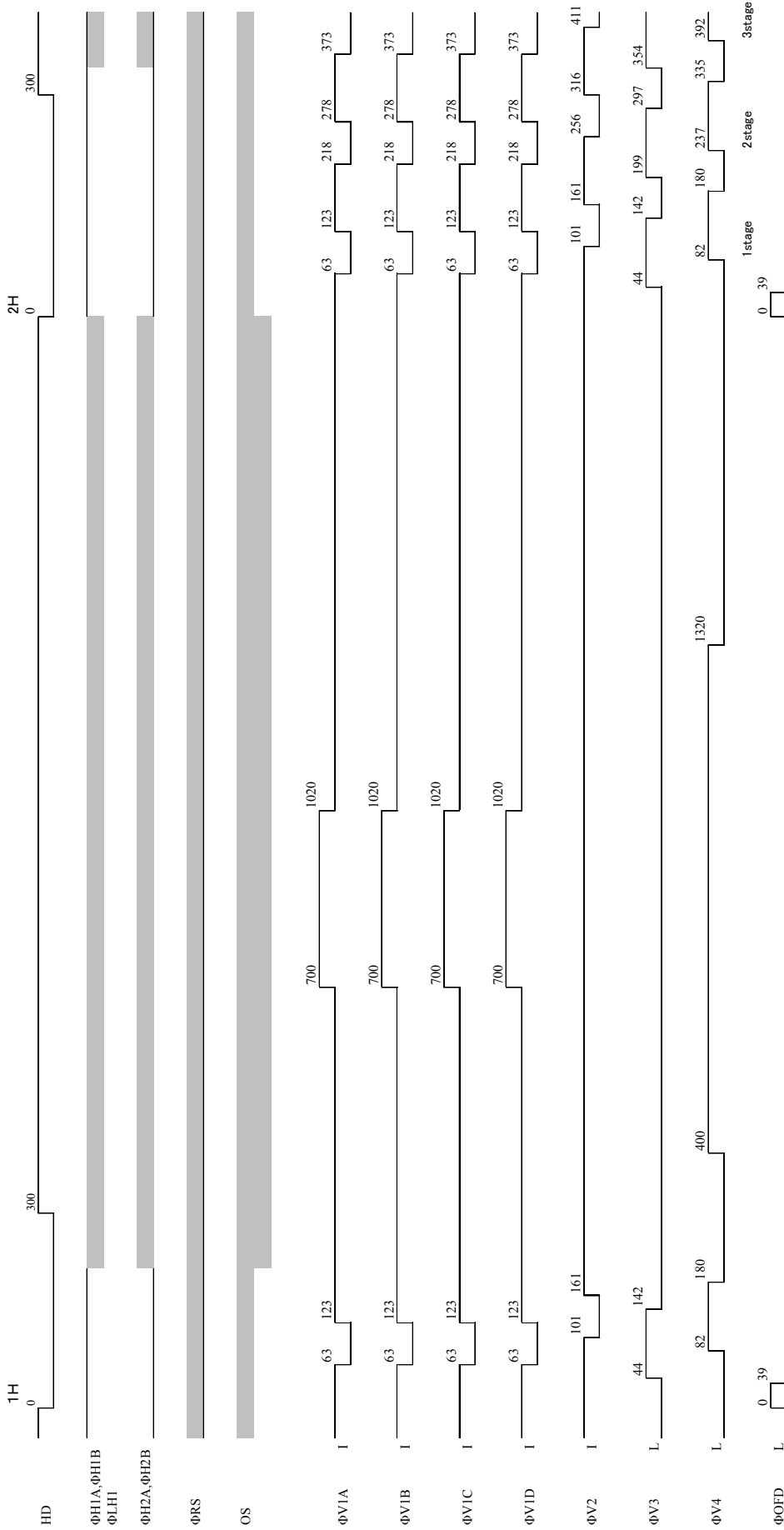

* Keep over the periods indicated in this timing chart when vertical transfer clock pulse is overlapping.

Horizontal transfer timing [Progressive scan mode[Center 568 line] fck=36MHz 29.97fps (ii)]

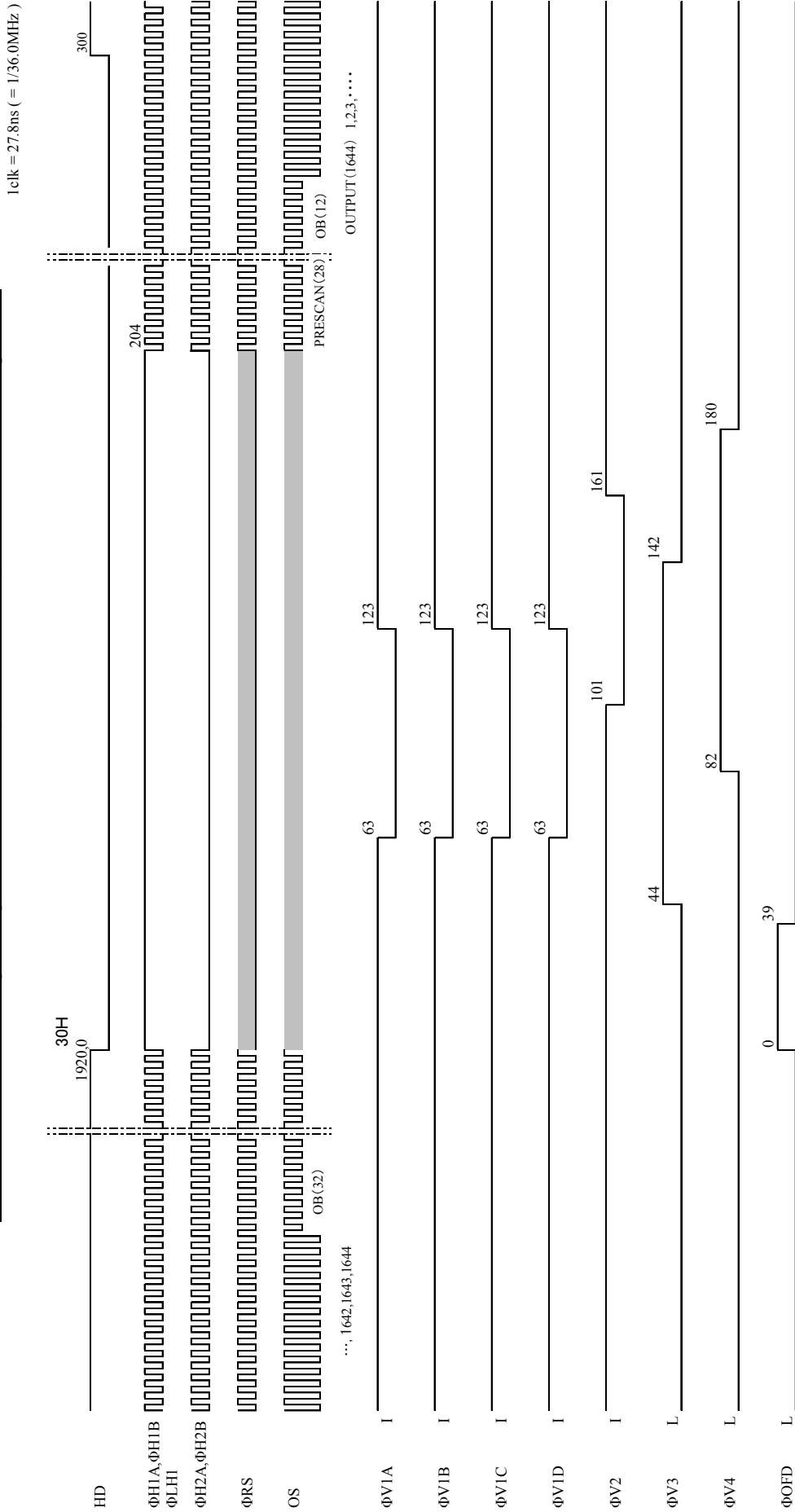

* Keep over the periods indicated in this timing chart when vertical transfer clock pulse is overlapping.

Fast shift transfer timing【 Progressive scan mode【Center 568 line】 fck=36MHz 29.97fps (iii)】

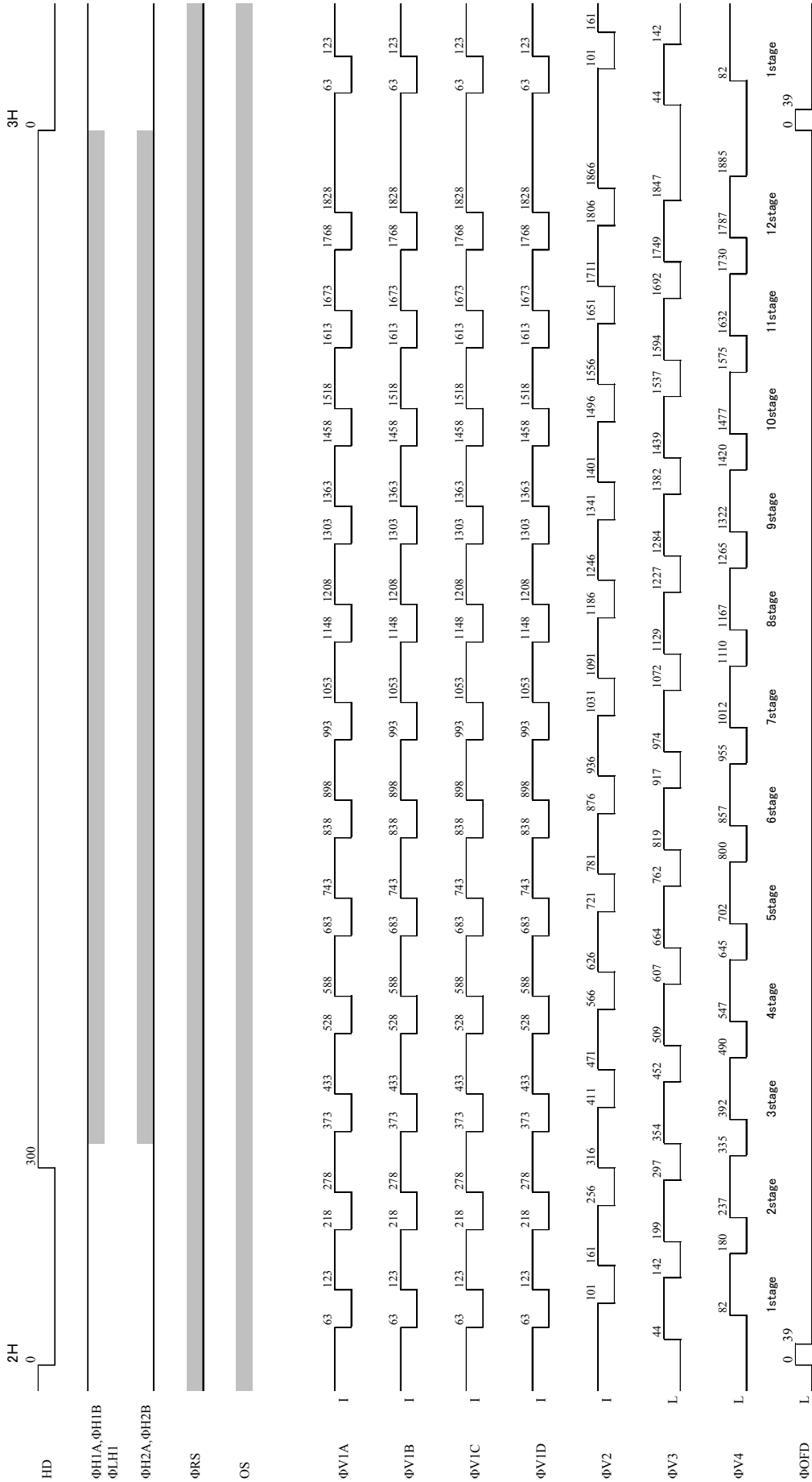

* Keep over the periods indicated in this timing chart when vertical transfer clock pulse is overlapping.

Charge swept transfer timing【Progressive scan mode【Center 568 line】 fck=36MHz, 29.97fps (iv)】

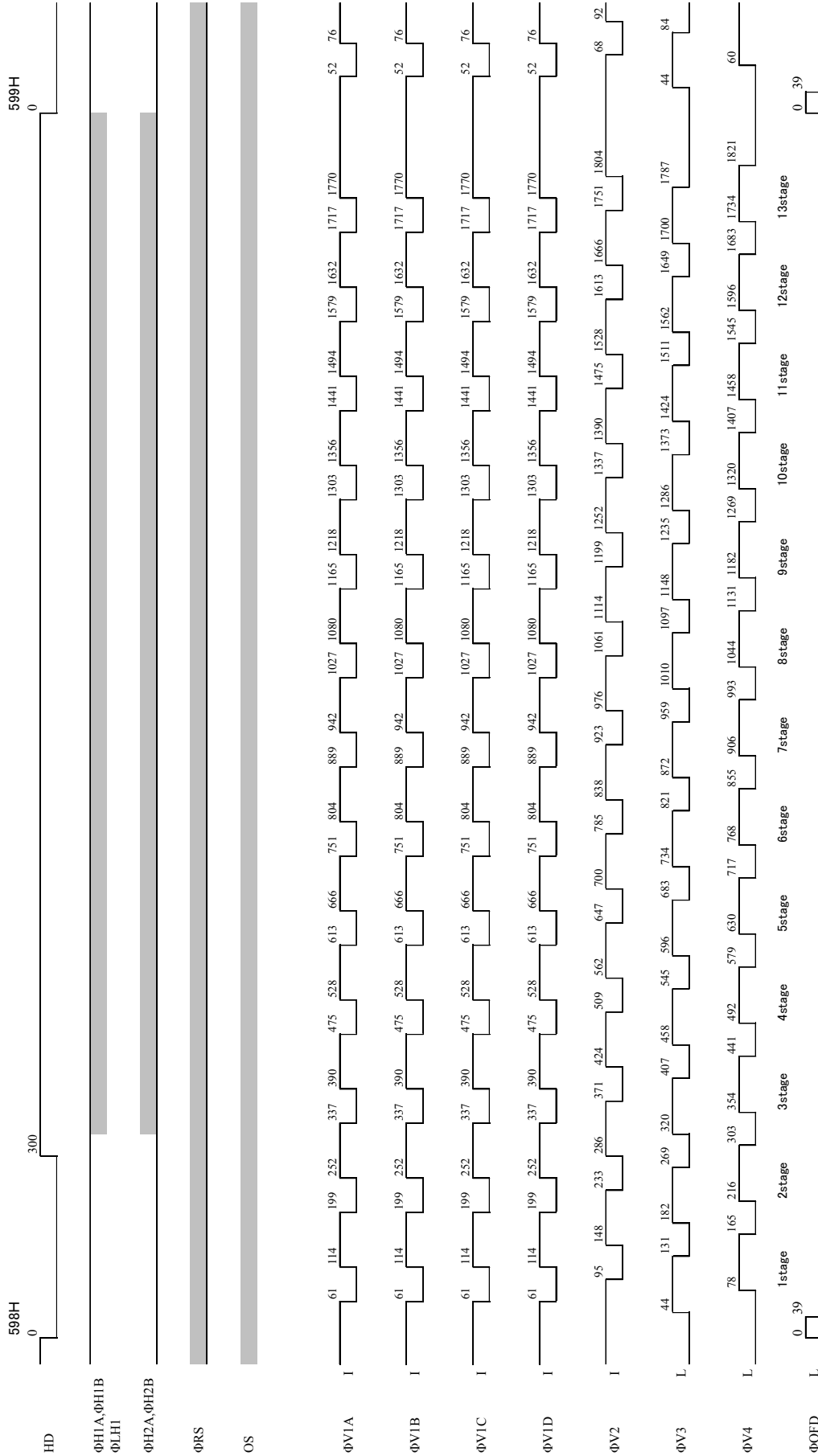

* Keep over the periods indicated in this timing chart when vertical transfer clock pulse is overlapping.

Charge swept transfer timing 【 Progressive scan mode【Center 568 line】 fclk=36MHz 29.97fps (iv) 】

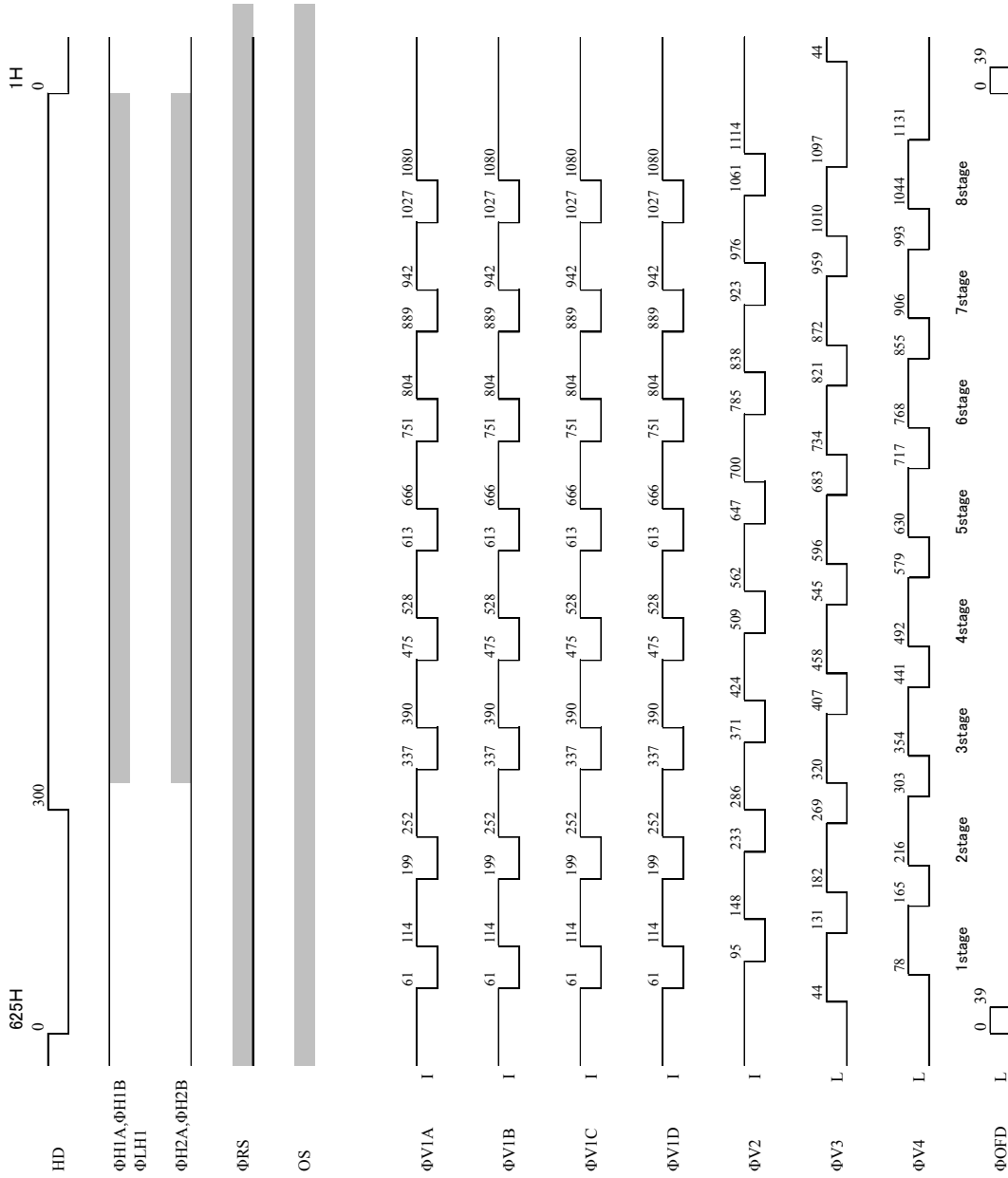

* Keep over the periods indicated in this timing chart when vertical transfer clock pulse is overlapping.

Vertical transfer timing [2/4-line readout mode] fck=36MHz 19.98fps

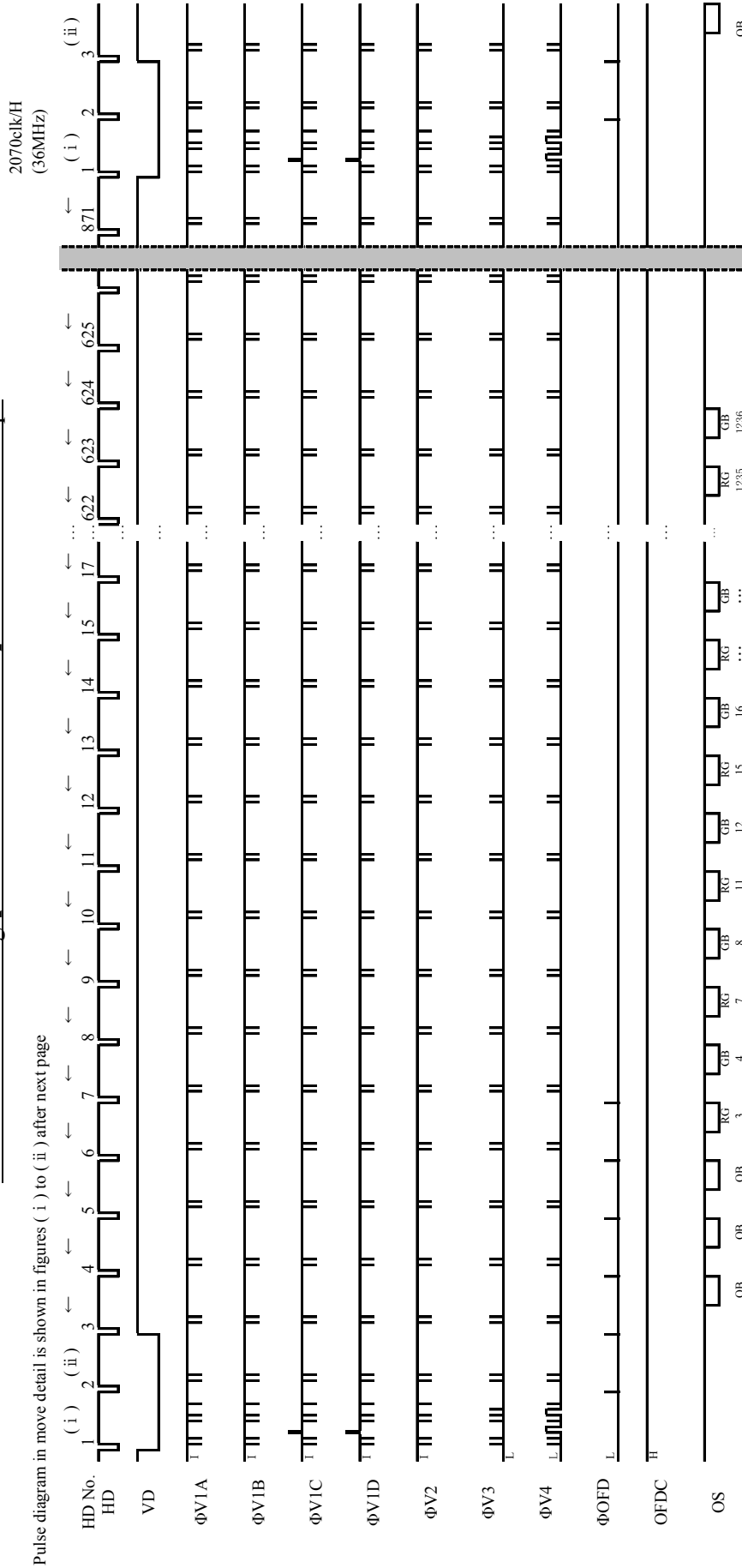

*HD 1 ~ HD870 = 2070clk, HD871 = 900clk

Readout timing 【 2/4-line readout mode 】 fck=36MHz 19.98fps (ii)

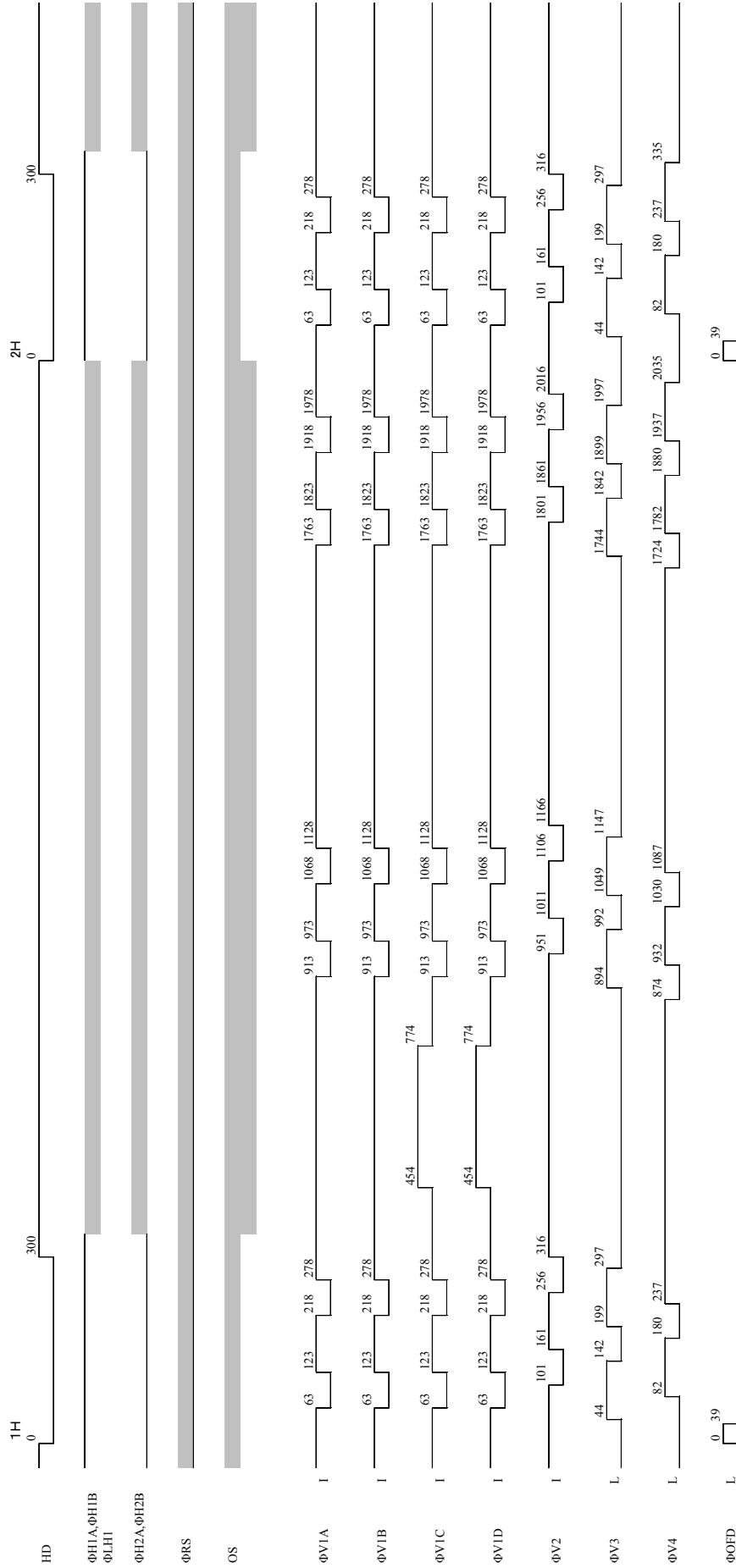

* Keep over the periods indicated in this timing chart when vertical transfer clock pulse is overlapping.

Horizontal transfer timing [2/4-line readout mode] fck=36MHz 19.98fps (ii)

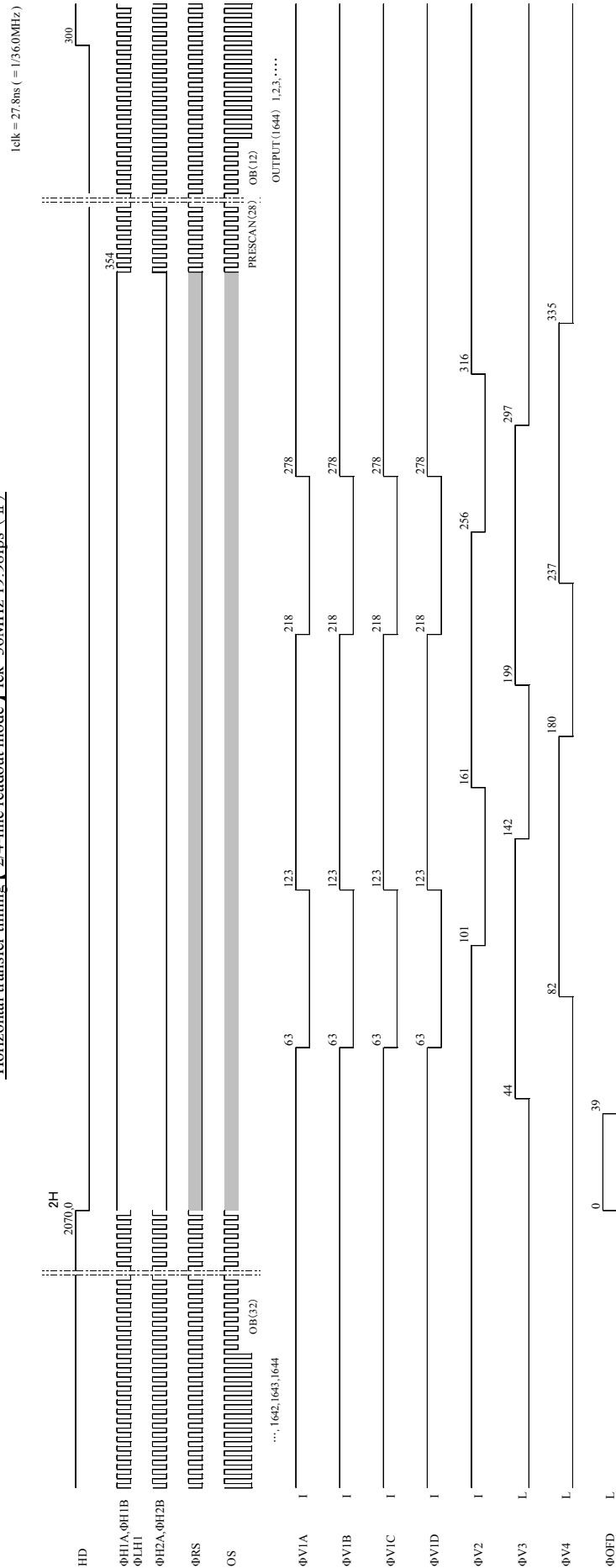

* Keep over the periods indicated in this timing chart when vertical transfer clock pulse is overlapping.

Vertical transfer timing [2/4-line readout mode[Center 568 line]] fck=36MHz 29.97fps

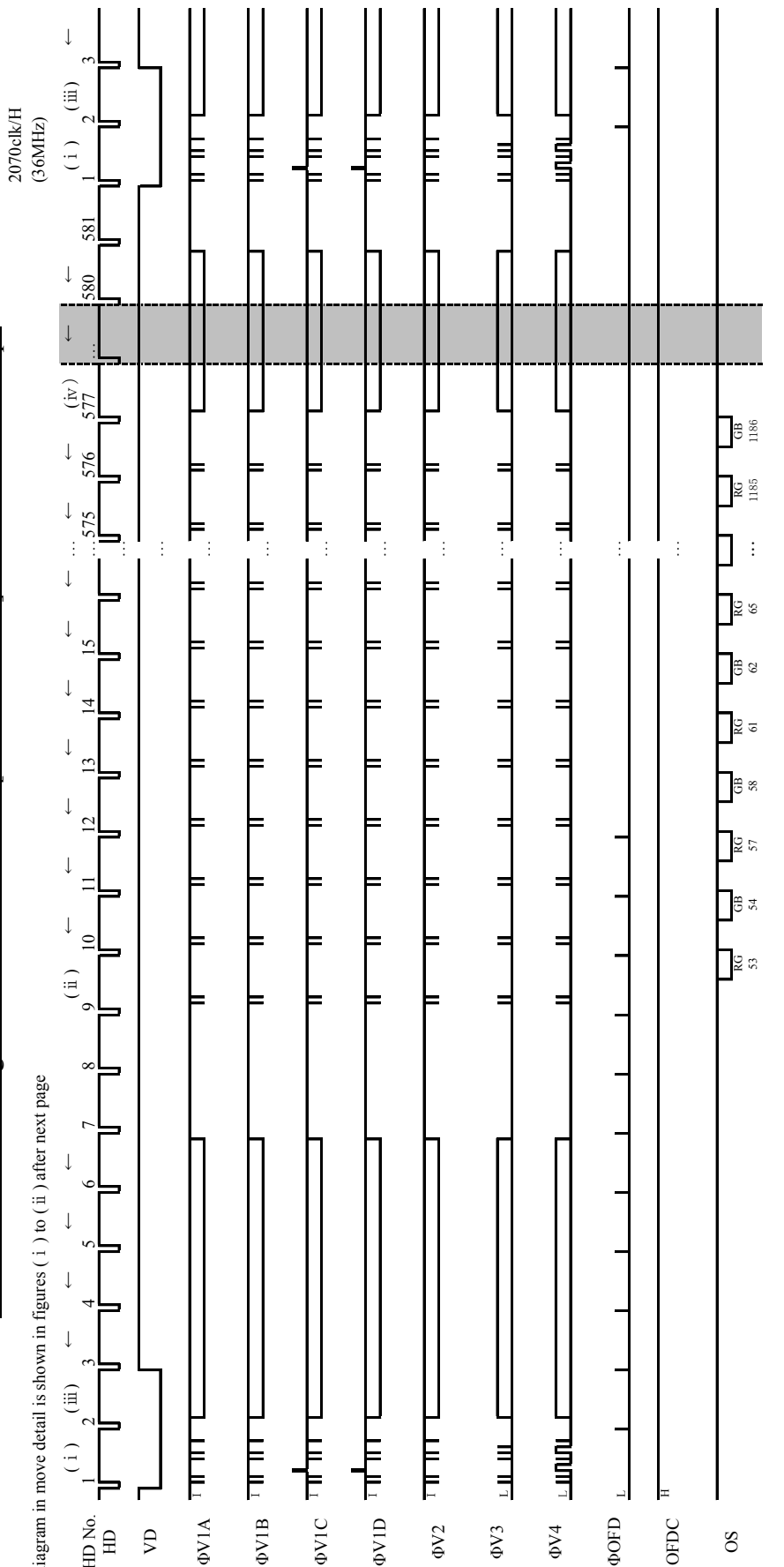

Pulse diagram in move detail is shown in figures (i) to (ii) after next page

*HD1~HD580=2070clk, HD581=601clk

Readout timing 【 2/4-line readout mode【Center 568 line】 fck=36MHz 29.97fps (i)

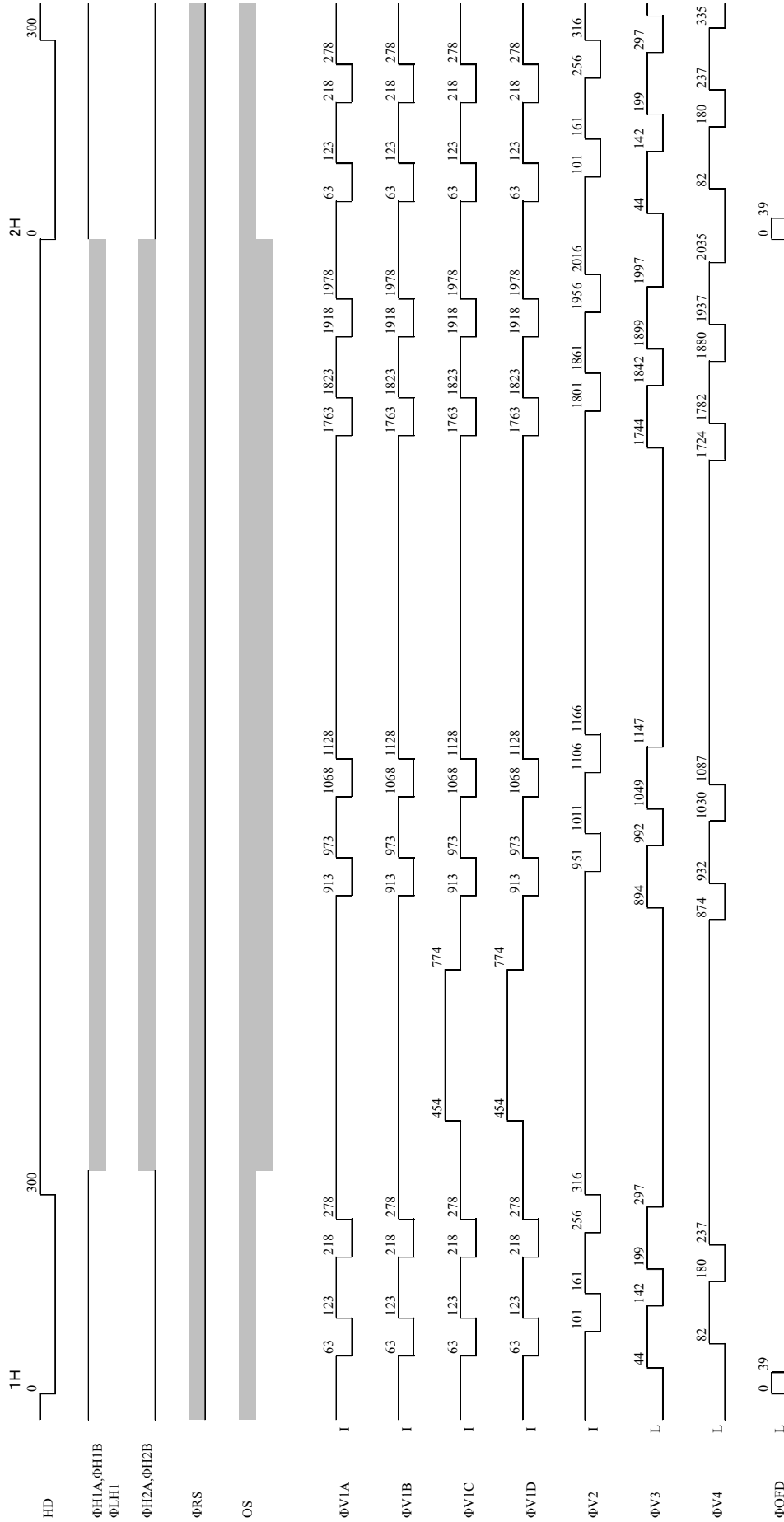

* Keep over the periods indicated in this timing chart when vertical transfer clock pulse is overlapping.

Horizontal transfer timing 【 2/4-line readout mode 】 fck=36MHz 19.98fps (ii)

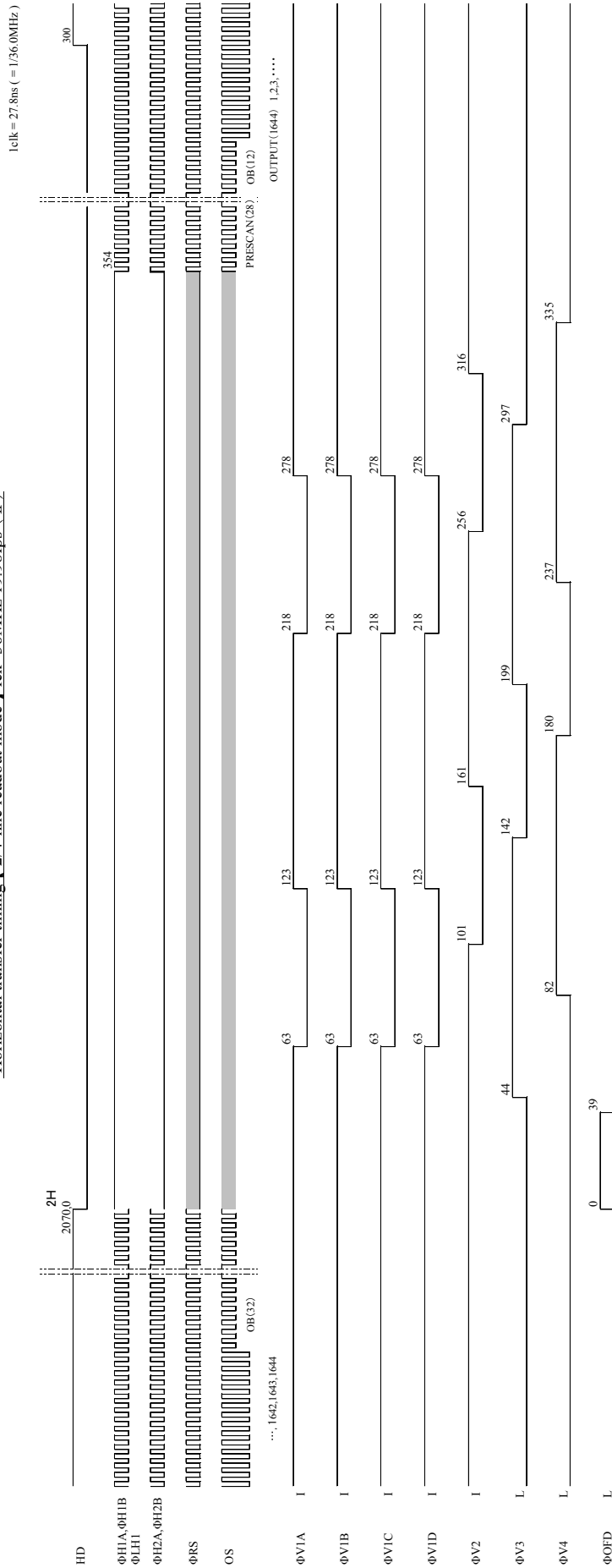

* Keep over the periods indicated in this timing chart when vertical transfer clock pulse is overlapping.

Fast shift transfer timing [2/4-line readout mode[Center 568 line] fck=36MHz 29.97fps (iii)]

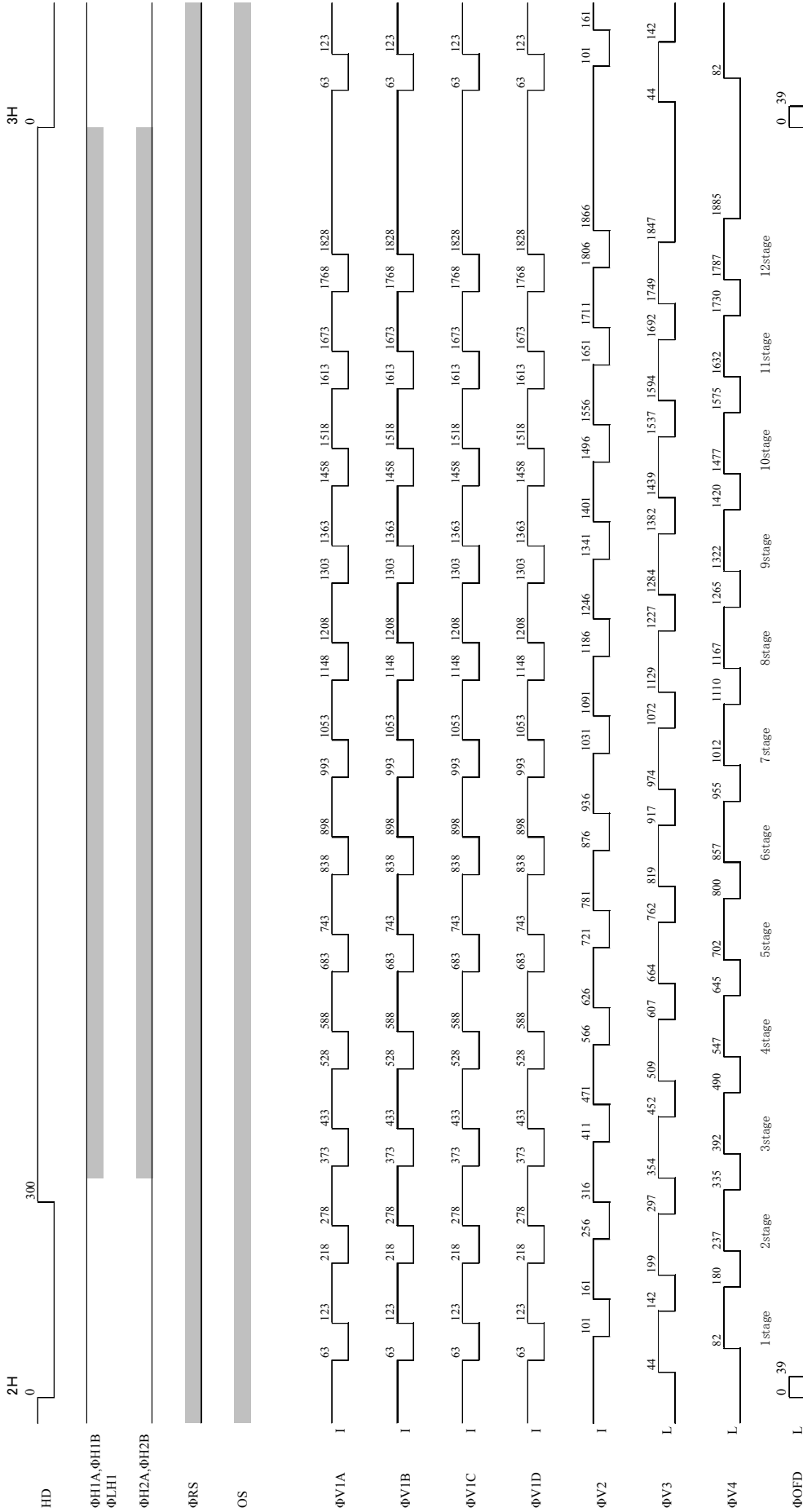

* Keep over the periods indicated in this timing chart when vertical transfer clock pulse is overlapping.

Charge swept transfer timing 【 2/4-line readout mode【Center 568 line】 fck=36MHz 29.97fps (iv) 】

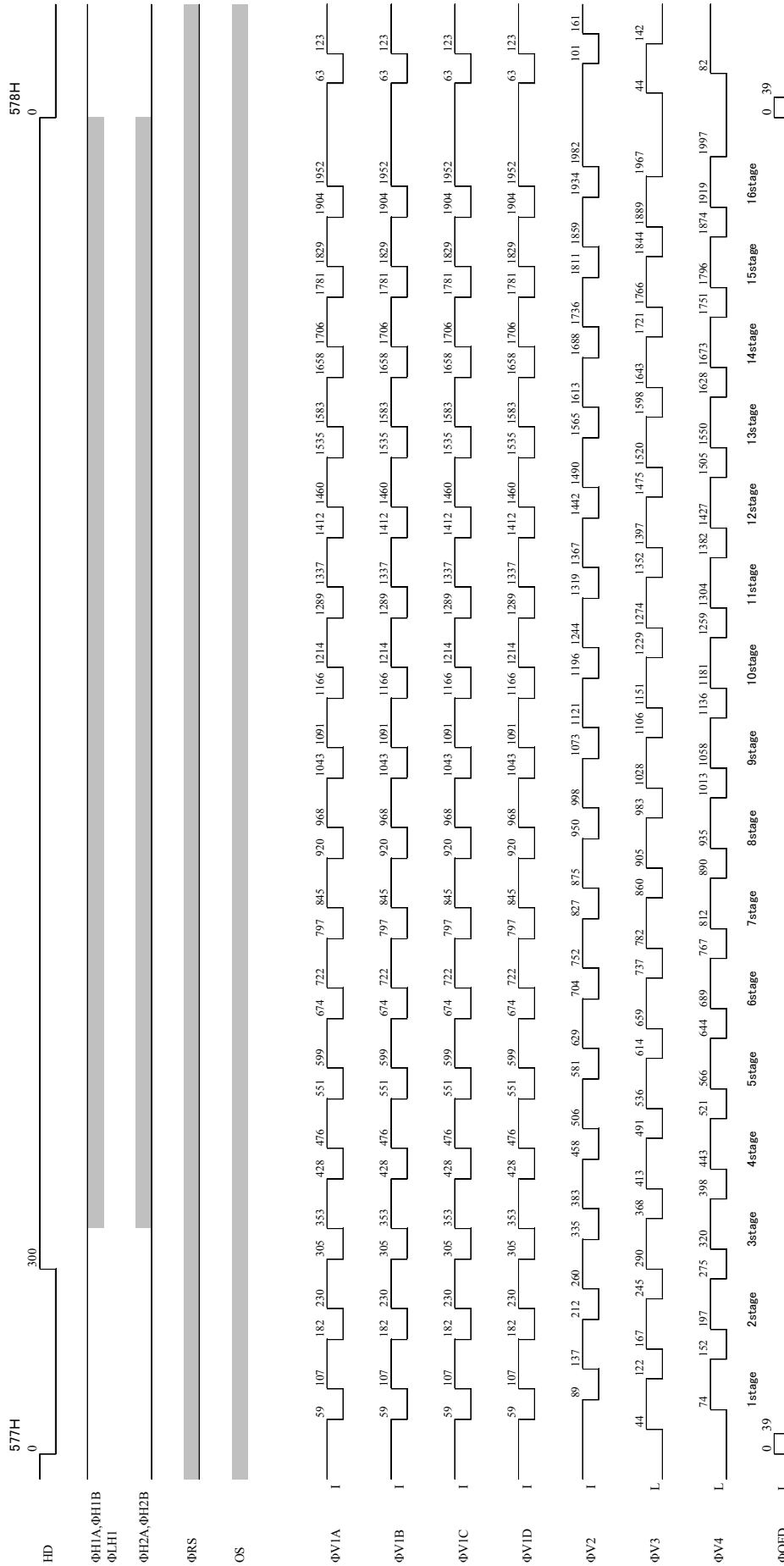

* Keep over the periods indicated in this timing chart when vertical transfer clock pulse is overlapping.

Vertical transfer timing [2-pixels addition readout mode] fck=36MHz 19.98fps

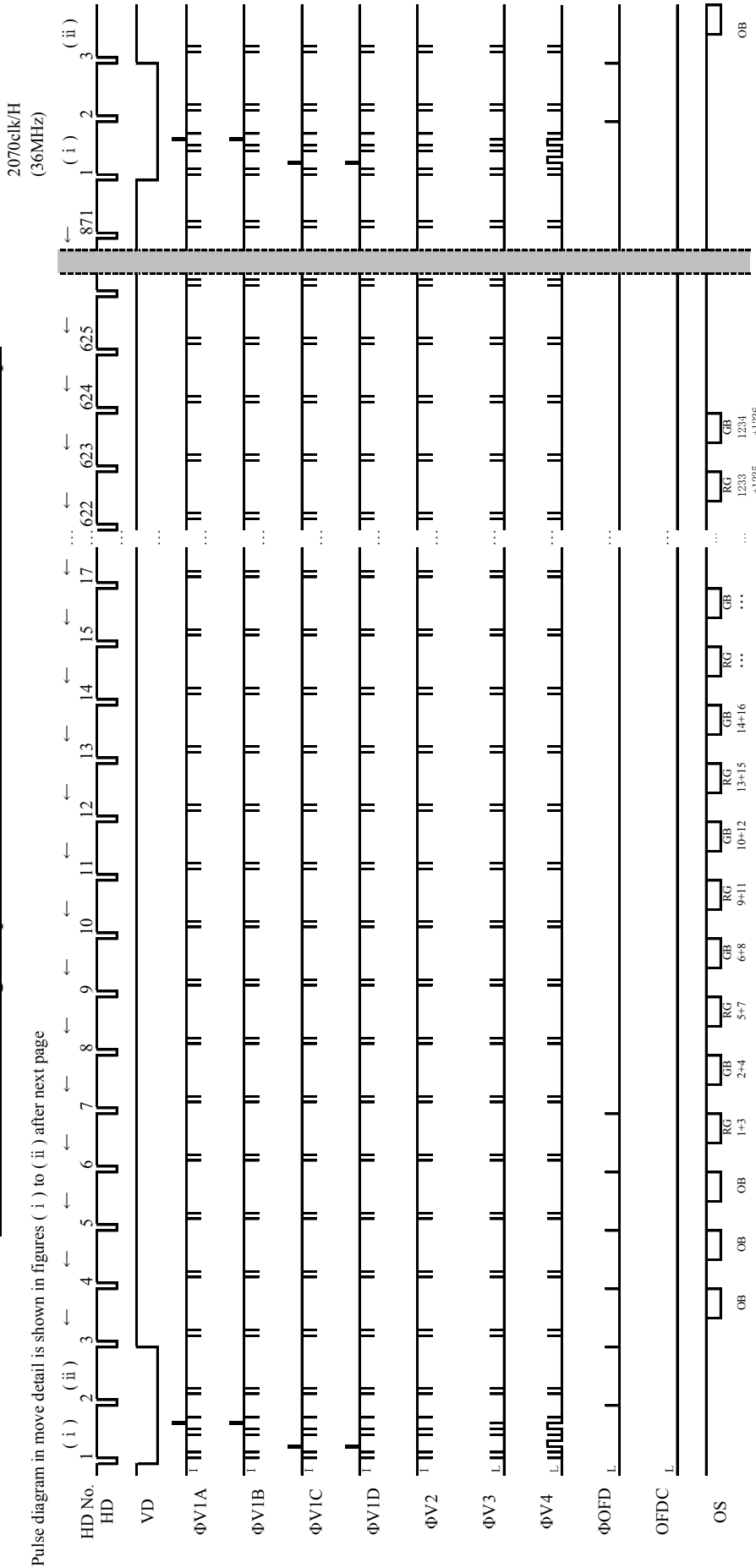

*HD1 ~ HD870 = 2070clk, HD871 = 900clk

Readout timing [2-pixels addition readout mode] fck=36MHz 19.98fps (ii)

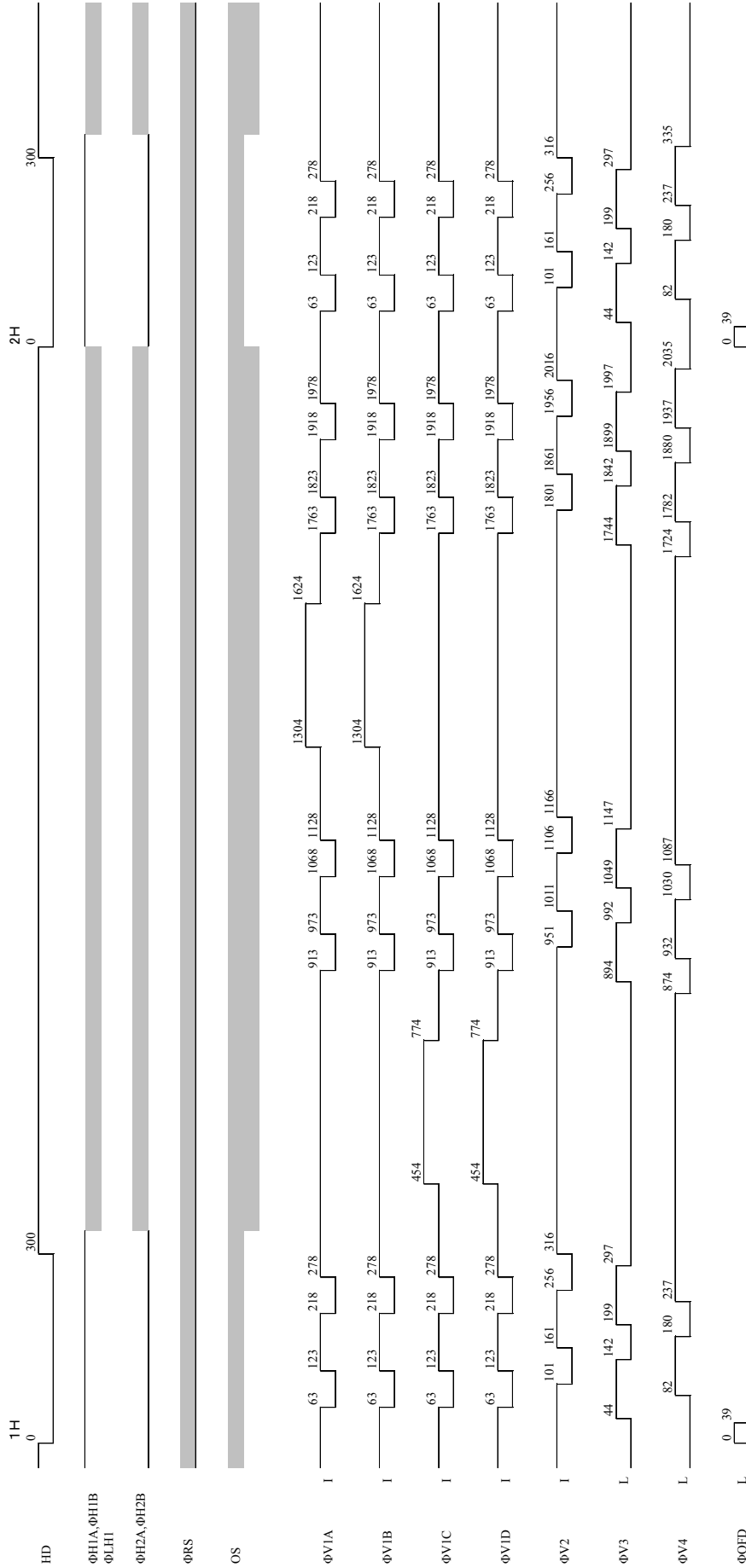

* Keep over the periods indicated in this timing chart when vertical transfer clock pulse is overlapping.

Horizontal transfer timing 【 2-pixels addition readout mode 】 fck=36MHz 19.98fps (ii)

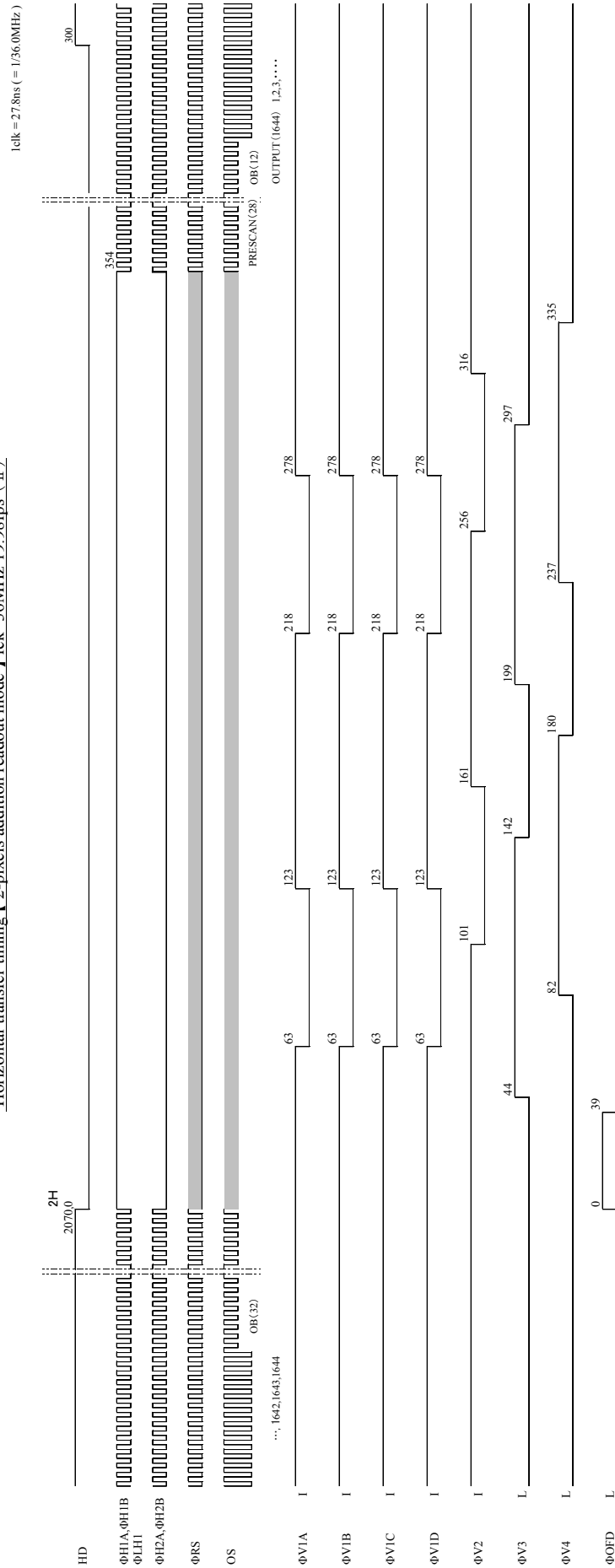

* Keep over the periods indicated in this timing chart when vertical transfer clock pulse is overlapping.

Vertical transfer timing [2-pixels addition readout mode[Center 568 line] fck=36MHz 29.97fps

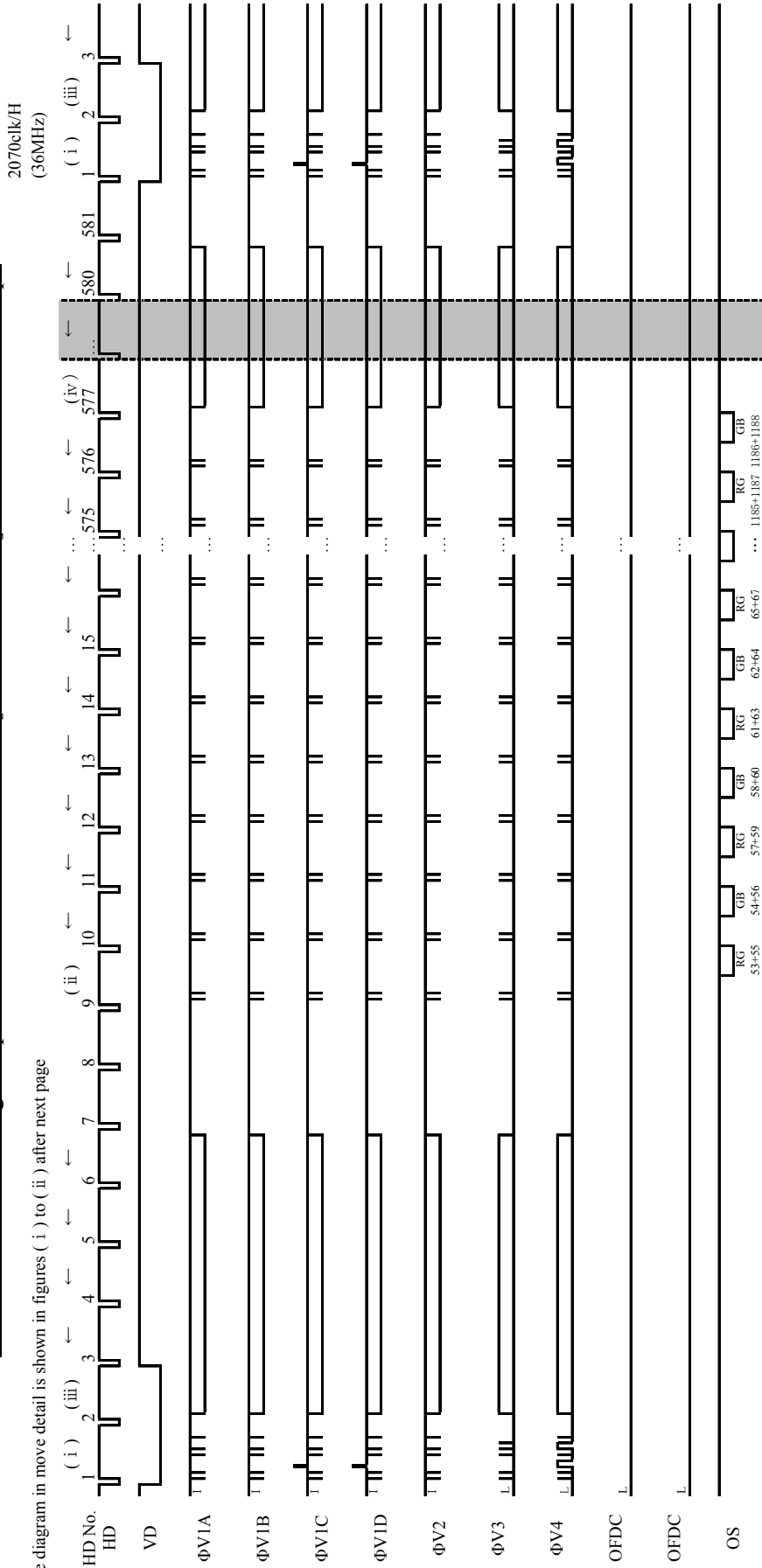

Pulse diagram in move detail is shown in figures (i) to (ii) after next page

*HD1~HD580=2070clk, HD581=601clk

Readout timing [2-pixels addition readout mode | Center 568 line] fck=36MHz 29.97fps (i)

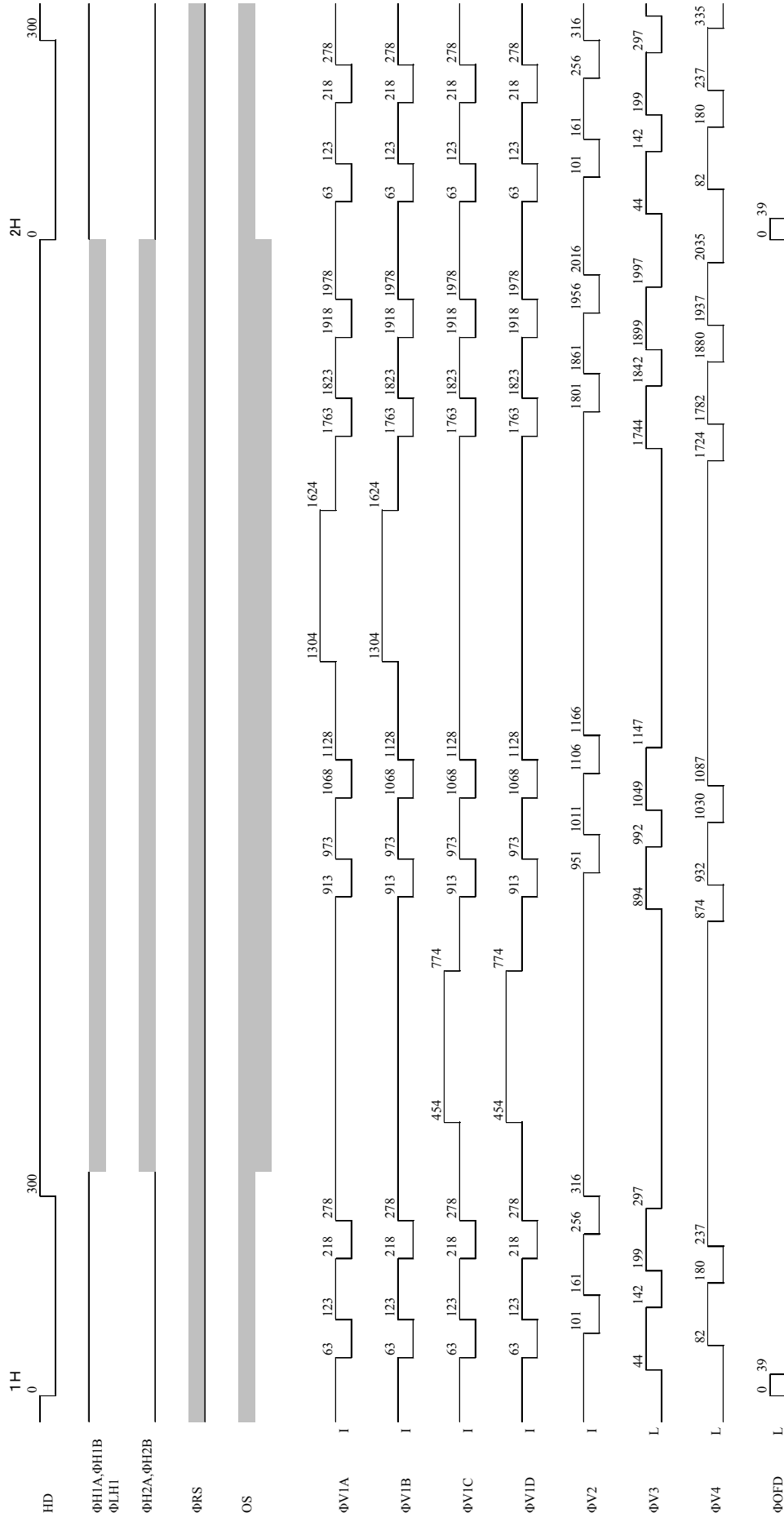

* Keep over the periods indicated in this timing chart when vertical transfer clock pulse is overlapping.

Horizontal transfer timing 【 2-pixels addition readout mode【Center 568 line】 fck=36MHz 29.97fps (ii) 】

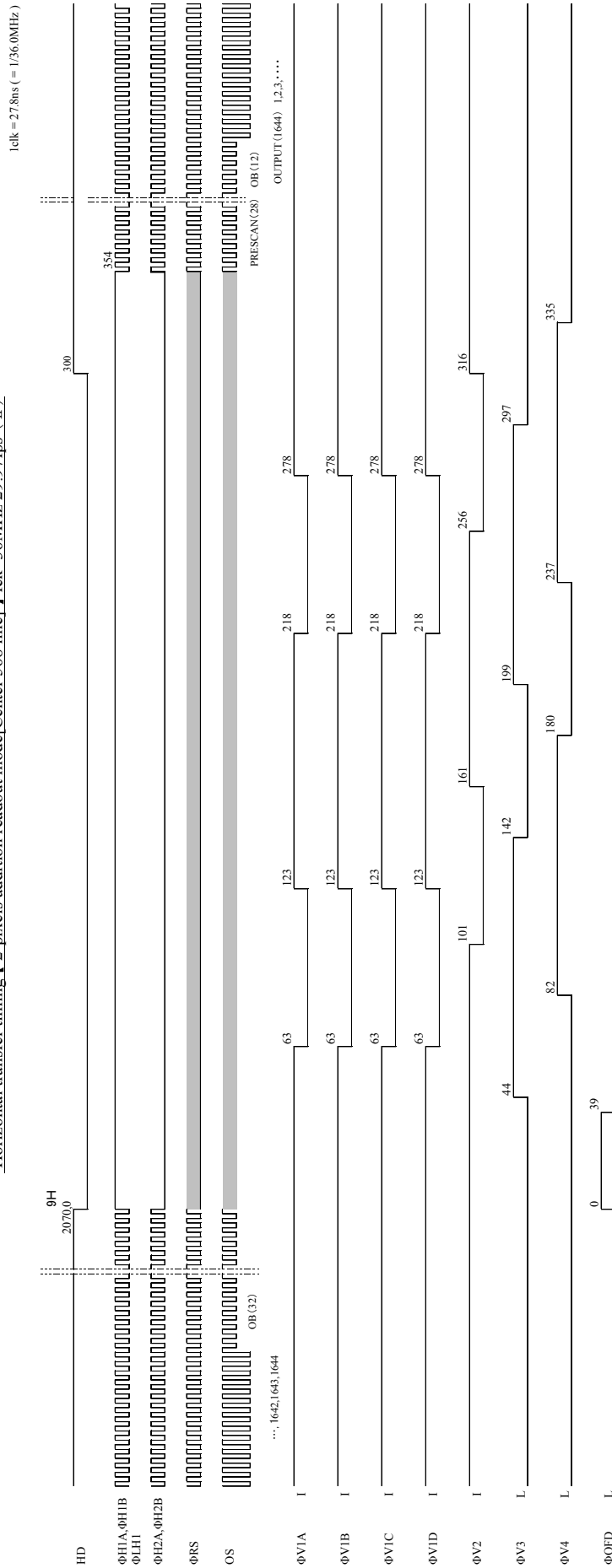

* Keep over the periods indicated in this timing chart when vertical transfer clock pulse is overlapping.

Fast shift transfer timing [2-pixels addition readout mode [Center 568 line]] fck=36MHz 29.97fps (iii)

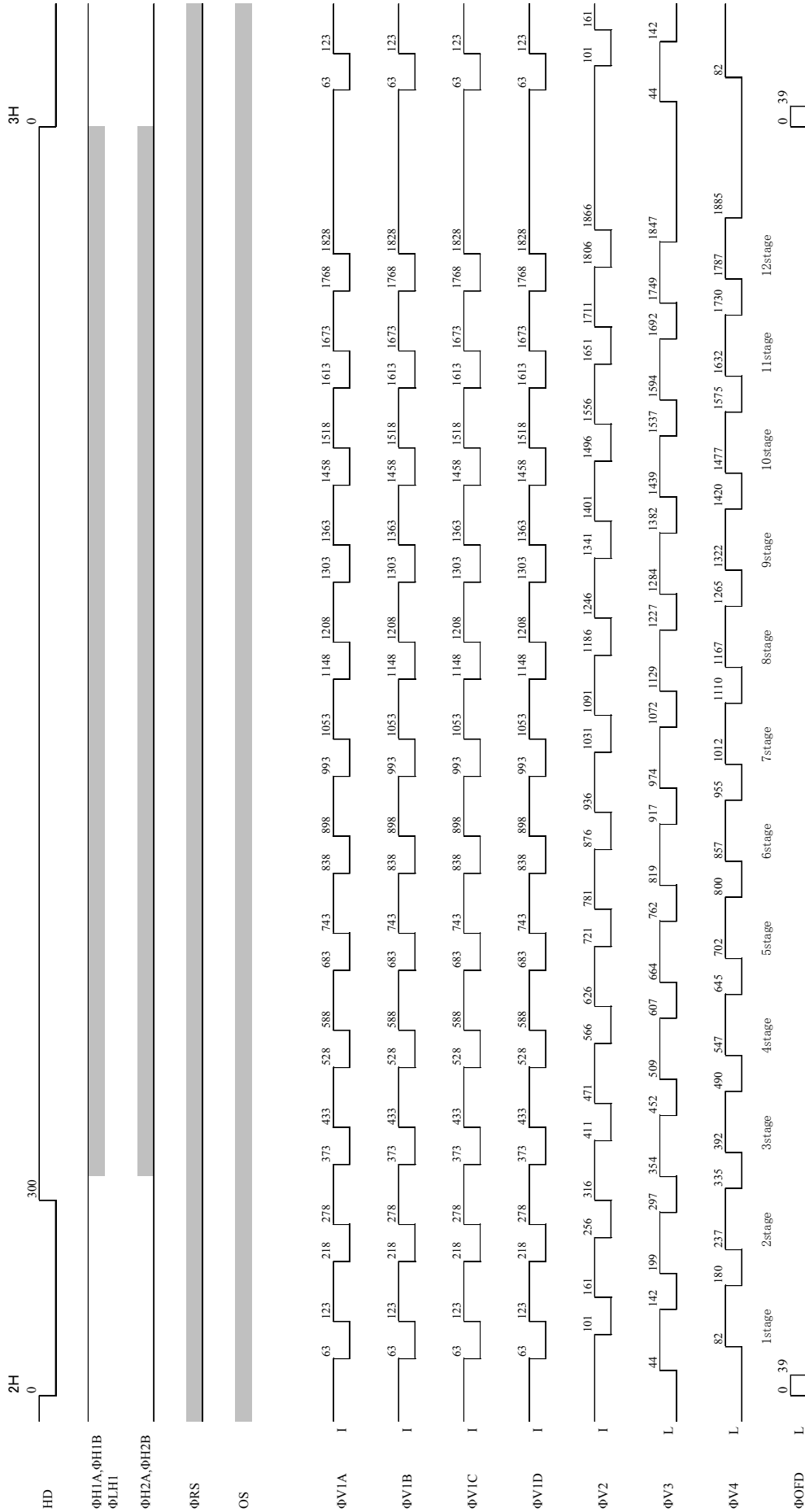

* Keep over the periods indicated in this timing chart when vertical transfer clock pulse is overlapping.

Charge swept transfer timing 【 2-pixels addition readout mode | Center 568 line | fck=36MHz 29.97fps (iv) 】

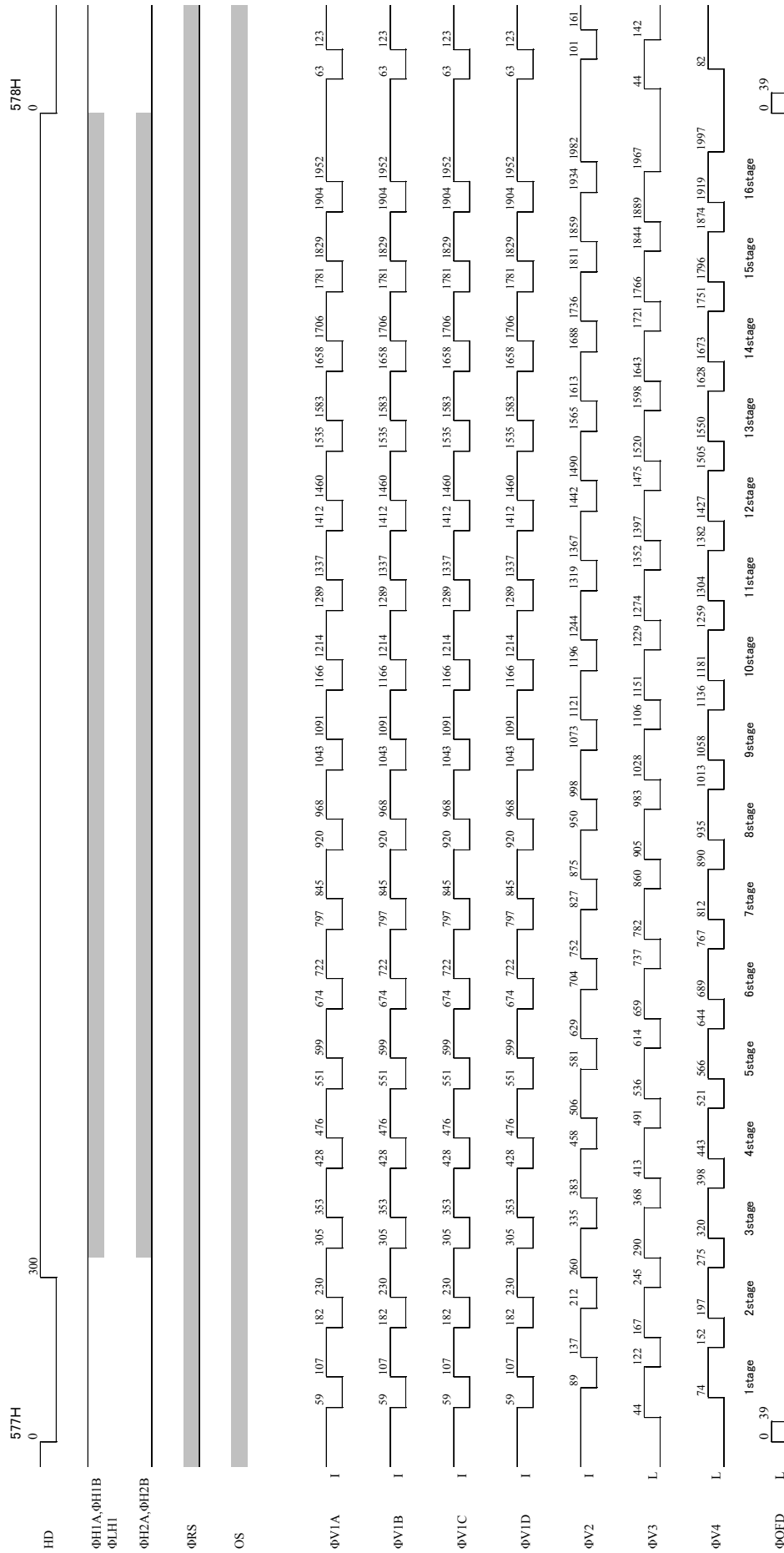

* Keep over the periods indicated in this timing chart when vertical transfer clock pulse is overlapping.

8 EXAMPLE OF STANDARD OPERATING CIRCUIT

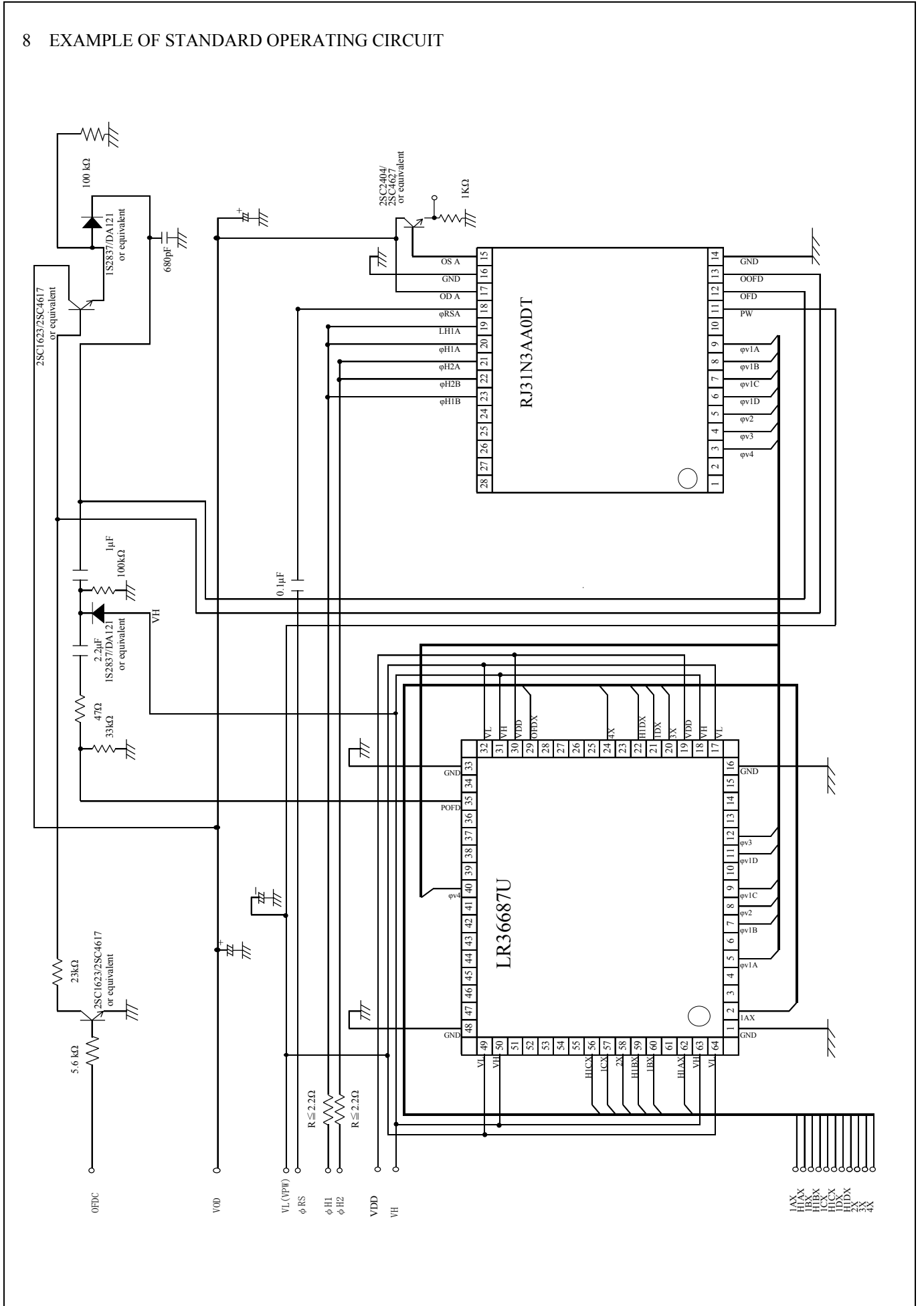

9 SPECIFICATION FOR BLEMISH (1/30 s frame accumulation)

1) Definition of blemish

| | Level of blemish (mV) | Permitted number of blemish | Comment |
|------------------------------|-----------------------|-----------------------------|--|
| White blemish (Exposed) | $50 \leq B$ | 0 | <ul style="list-style-type: none"> • See fig.9-1 (a), fig.9-2. • $V_{out} = V_{std}$ |
| | $B < 50$ | no count | |
| Black blemish (Exposed) | $120 \leq B$ | 0 | |
| | $55 \leq B < 120$ | 15 | |
| | $40 \leq B < 55$ | 15 | |
| | $B < 40$ | no count | |
| White blemish (Non-Exposed) | $100 < B$ | 0 | <ul style="list-style-type: none"> • See fig.9-1 (b), fig.9-2 • $N \leq 60$ • $M + N \leq 300$ |
| | $20 < B \leq 100$ | N | |
| | $2.5 < B \leq 20$ | M | |
| | $B \leq 2.5$ | no count | |
| White blemish (Shutter mode) | $5.0 \leq B$ | 0 | <ul style="list-style-type: none"> • See fig.9-1 (a), fig.9-2. • $V_{out} = V_{std}/10$ • The electronic shutter speed is set at 1/10000 s |
| | $B < 5.0$ | no count | |
| Black blemish (Shutter mode) | $5.0 \leq B$ | 0 | |
| | $B < 5.0$ | no count | |

*Total number of white blemish (non-exposed: $20 < B \leq 100$) and black blemish (exposed: $55 \leq B < 120$) are less than 2 in arbitrary 8×8 pixels areas(ignore color filter).

ex. The defects are less than 2 in the subsequent area surrounded by bold lines.

| | | | | | | | | | |
|---|----------|---|----------|---|----------|---|----------|---|----------|
| G | B | G | B | G | B | G | B | G | B |
| R | G | R | G | R | G | R | G | R | G |
| G | B | G | B | G | B | G | B | G | B |
| R | G | R | G | R | G | R | G | R | G |
| G | B | G | B | G | B | G | B | G | B |
| R | G | R | G | R | G | R | G | R | G |
| G | B | G | B | G | B | G | B | G | B |
| R | G | R | G | R | G | R | G | R | G |
| G | B | G | B | G | B | G | B | G | B |
| R | G | R | G | R | G | R | G | R | G |

- 《note》
- B : Blemish level defined in fig. 9-1.
 - V_{out} : Average output voltage
 - V_{std} : 150 mV (The average output voltage of G signal). The standard output voltage defined in the specification of the characteristics.

【MEASURING CONDITION】

- $T_a : 60^\circ\text{C}$
- Measuring block diagram

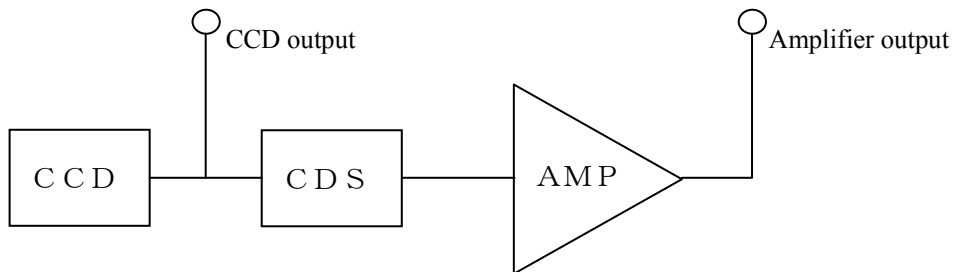

The output voltage is measured at the CCD output.
 The gain of the amplifier is adjusted to the unity between the CCD output and the amplifier output.

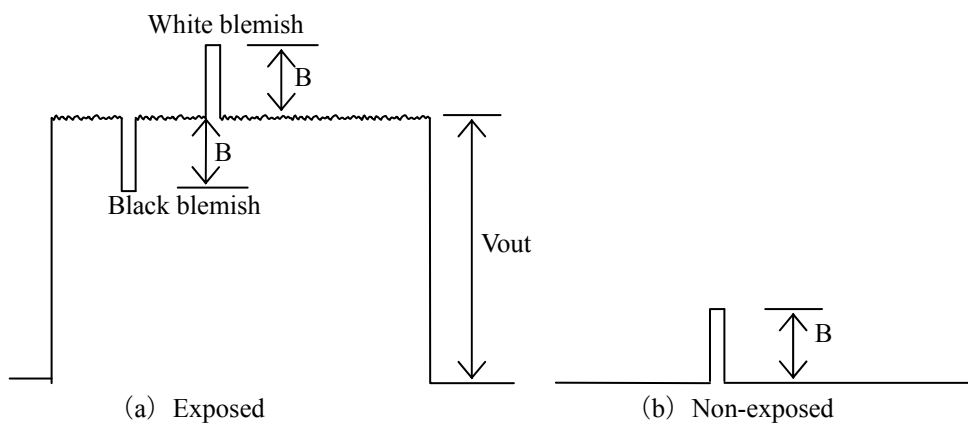

fig. 9-1 Definition of blemish level

(The wave form is the luminance signal measured at the Amplifier output)

【MEASURING AREA】

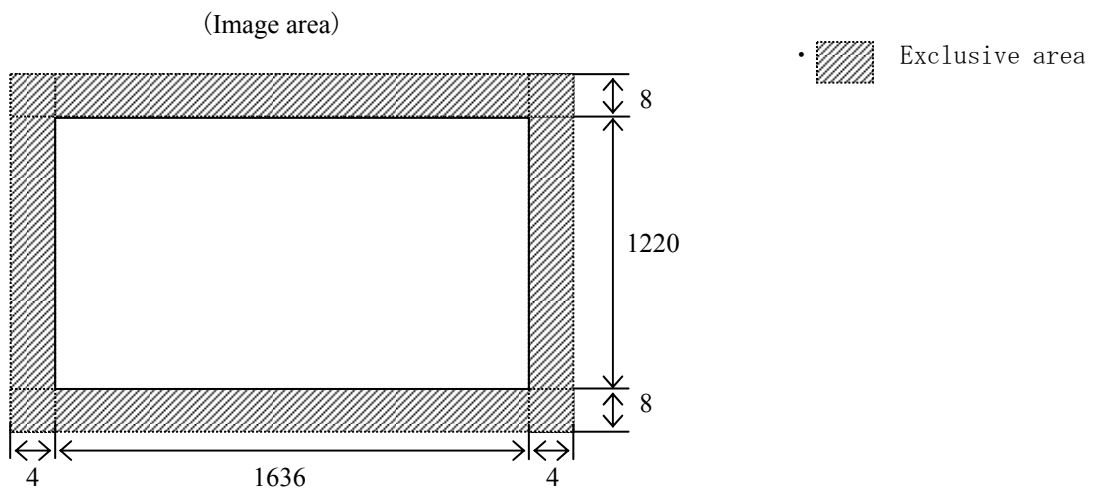

fig. 9-2 Definition of the measuring area

10 PRECAUTIONS

10.1 Package Breakage

In order to prevent the package from being broken, observe the following instructions:

- 1) The CCD is a precise optical component and the package material is plastic.
Therefore,
 - Take care not to drop the device when mounting, handling, or transporting.
 - Avoid giving a shock to the package. Especially when leads are fixed to the socket or the circuit board, small shock could break the package more easily than when the package isn't fixed.
- 2) When mounting the package on the housing, be sure that the package is not bent.
 - If a bent package is forced into place between a hard plate or the like, the package may be broken.
- 3) If any damage or breakage occurs on the surface of the glass cap, its characteristics could deteriorate.
Therefore,
 - Do not hit the glass cap.
 - Do not give a shock large enough to cause distortion.
 - Do not scrub or scratch the glass surface.
 - Even a soft cloth or applicator, if dry, could cause flaws to scratch the glass.

10.2 Electrostatic Damage

As compared with general MOS-LSI, CCD has lower ESD.

Therefore, take the following antistatic measures when handling the CCD:

- 1) Always discharge static electricity by grounding the human body and the instrument to be used.
To ground the human body, provide resistance of about $1\text{ M}\Omega$ between the human body and the ground to be on the safe side.
- 2) When directly handling the device with the fingers, hold the part without leads and do not touch any lead.
- 3) To avoid generating static electricity,
 - a. do not scrub the glass surface with cloth or plastic
 - b. do not attach any tape or labels
 - c. do not clean the glass surface with dust-cleaning tape
- 4) When storing or transporting the device, put it in a container of conductive material.

10.3 Dust and Contamination

Dust or contamination on the glass surface could deteriorate the output characteristics or cause a scar. In order to minimize dust or contamination on the glass surface, take the following precautions:

- 1) Handle the CCD in a clean environment such as a cleaned booth. (The cleanliness level should be, if possible, class 1,000 at least.)
 - 2) Do not touch the glass surface with the fingers. If dust or contamination gets on the glass surface, the following cleaning method is recommended:
 - Dust from static electricity should be blown off with an ionized air blower.
For anti-electrostatic measures, however, ground all the leads on the device before blowing off the dust.
 - The contamination on the glass surface should be wiped off with a clean applicator soaked in Isopropyl alcohol. Wipe slowly and gently in one direction only.
 - Frequently replace the applicator and do not use the same applicator to clean more than one device.
- ※ Note: In most cases, dust and contamination are unavoidable, even before the device is first used. It is, therefore, recommend that the above procedures should be taken to wipe out dust and contamination before using the device.

10.4 Other

- 1) Soldering should be manually performed within 5 seconds at 350°C maximum at the tip of soldering iron.
- 2) Avoid using or storing the CCD at high temperature or high humidity as it is a precise optical component. Do not give a mechanical shock to the CCD.
- 3) Do not expose the device to strong light. For the color device, long exposure to strong light will fade the color of the color filters.

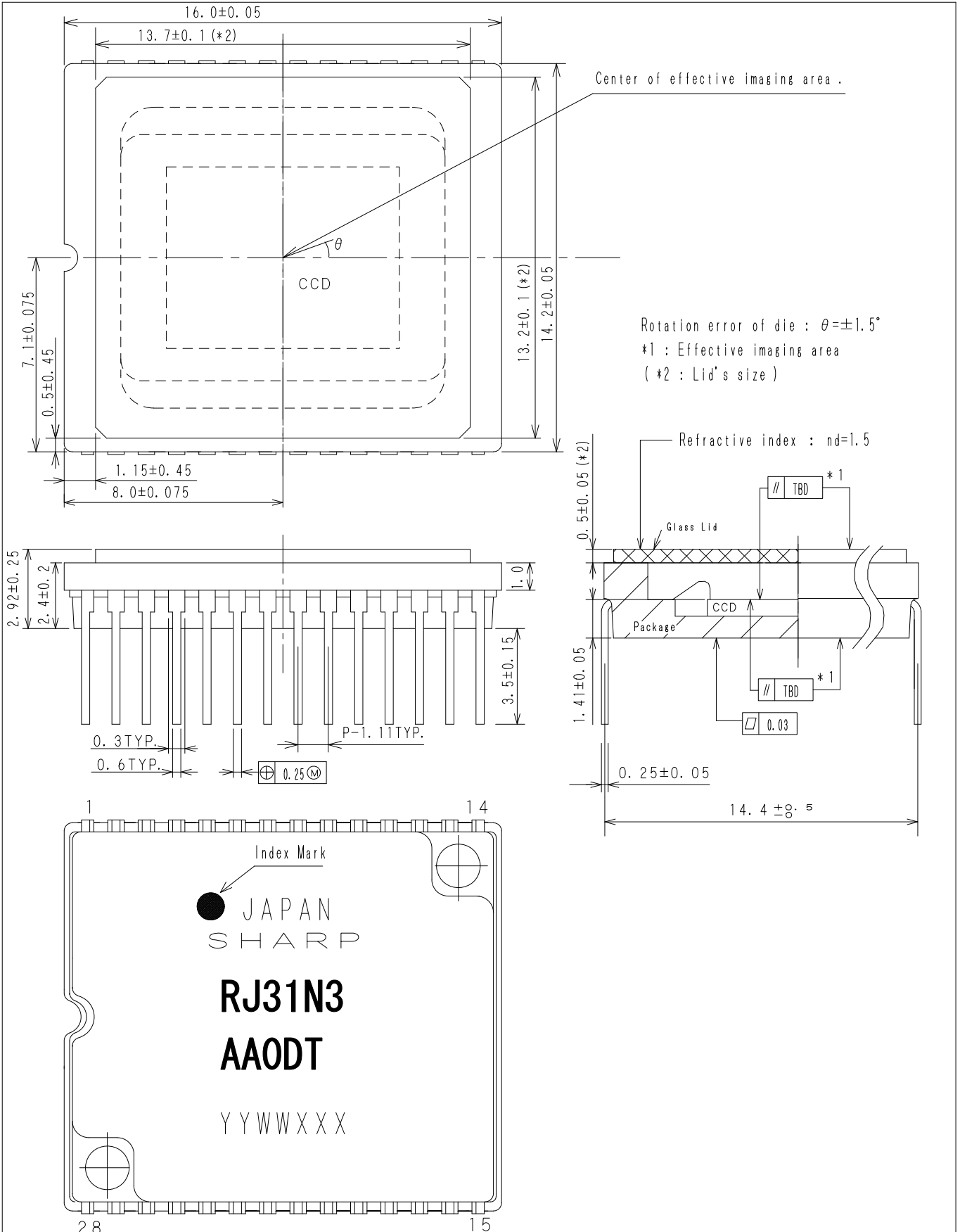

(UNIT : mm)

| | | | | | | | |
|---|-----------|----------------|---|---|---|---|----|
| 材質 MATERIAL | 仕上 FINISH | 名称 NAME | WDIP28-P-560 Package Outline Specification | | | | |
| Assembly Process Production Engineering Dept. | | コード CODE | | | | | |
| ELECTRONIC COMPONENTS AND DEVICES GROUP | | 図番 DRAWING No. | G | D | P | 0 | 28 |
| SHARP CORPORATION | | | J | - | 0 | 1 | X |
| | | | 0 | | | | |