



Socle Technology Corporation
| Foxconn Technology Group

FOXCONN
鴻海科技集團

Introduction of Socle Technology

Presenter:

1/17/24



23 years



Channel Service

World Wide Sales Channel : Locations and Values



 Global online Distributors

 Socle Reps / Distributors

 Socle Sales Office



Representing Foxconn Group Brands at several regions
Plenty connections, sales routes around the world



Experienced FAE in consumer electronics, such as Air purifier, Camera, Distance ranging, Robot...etc.



Leveraging engineering resource in Foxconn group for building up sensor modules



Power Semiconductor

FOXCONN

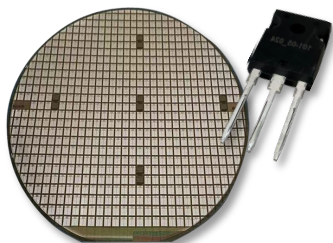

HALOGEN
FREE
RoHS
COMPLIANT

Applications



Battery Chargers



DC/DC converters



Industrial Inverter

Features

Item	Parameter	
Drain-Source Breakdown Voltage	1200	1700V
RDS	12, 16, 20, 40, 70mohm	40mohm, 1ohm, 50ohm
Guaranteed performance over temperature	25°C ~ +175°C.	

FOXCONN

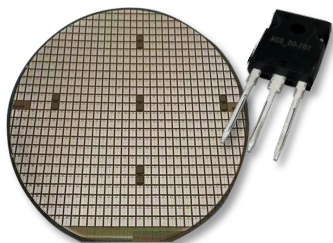

**HALOGEN
FREE** **RoHS
COMPLIANT**

Emerald series	Gen 1					Gen 2
	1200V					
	12mohm	16mohm	20mohm	40mohm	70mohm	16mohm
Drain-Source Breakdown Voltage (BV)	1200V	1200V	1200V	1200V	1200V	1200V
Gate-source threshold voltage (Vth)	2.9V	2.9V	2.9V	2.9V	2.9V	3V
Drain-source on-state resistance (Ron)	12mohm	16mohm	20mohm	40mohm	70mohm	16mohm
Continuous DC drain current (Id)	125A	105A	85A	55A	35A	100A
Gate-to-drain charge (Qgd)	95nc	69nc	55nc	35nc	27nc	94nc

Rutile series Gen 2	1200V				
	12mohm	16mohm	20mohm	40mohm	70mohm
Drain-Source Breakdown Voltage (BV)	1200V	1200V	1200V	1200V	1200V
Gate-source threshold voltage (Vth)	2.9V	2.9V	2.9V	2.9V	2.9V
Drain-source on-state resistance (Ron)	12mohm	16mohm	20mohm	40mohm	70mohm
Continuous DC drain current (Id)	135A	110A	90A	55A	35A
Gate-to-drain charge (Qgd)	94nc	70nc	55nc	28nc	16nc

Power Isolation

FOXCONN



Applications



AC brushless



Induction Heating



Industrial Inverter

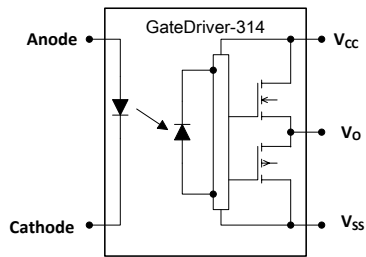

Features

Item	Parameter
Maximum peak output current	0.8A, 1A, 3A, 4A
Rail-to-rail output voltage	Yes
Maximum propagation delay	110 ns
Under Voltage Lock-Out protection (UVLO) with hysteresis	Yes
Wide operating range	10 to 30 Volts (VCC)
Guaranteed performance over temperature	-40°C ~ +110°C.
Safety approval	UL, VDE, CQC





Selection Table							
Part number	Package	Status	Peak Output Current (A)	V _{iso} (Vrms)	V _{CC} (V)	T _{PLH} /T _{PHL} (Max)	T _{OPR} (°C)
FSS-5701P/W-T1V	LSOP6	MP	0.8	5000	10 ~ 30	110ns	-40 ~ 110
FSS-314P/W-T1V	LSOP6	MP	1	5000	10 ~ 30	110ns	-40 ~ 110
FSS-341P/W-T1V	LSOP6	MP	3	5000	15 ~ 30	110ns	-40 ~ 110
FSS-343P/W-T1V	LSOP6	MP	4	5000	15 ~ 30	110ns	-40 ~ 110

Cross Reference

Gate Driver				
Part number	Package	Feature	BROADCOM	TOSHIBA
FSS-5701P/W-T1V	LSOP6	0.8A	---	---
FSS-314P/W-T1V	LSOP6	1A	ACPL-P314	TLP5701
FSS-341P/W-T1V	LSOP6	3A	ACPL-P341	TLP5754
FSS-343P/W-T1V	LSOP6	4A	ACPL-P343	TLP5754

FOXCONN

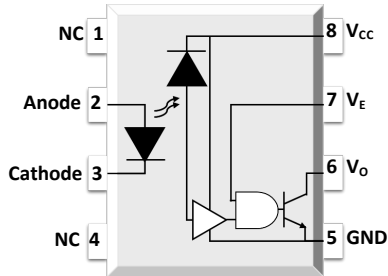
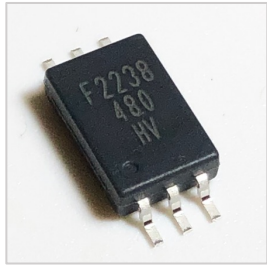

HALOGEN
FREE

RoHS
COMPLIANT



Applications

- Ground loop elimination
- LSTTL to TTL
- LSTTL or CMOS
- Line receiver
- data transmission
- Switching power supply
- Pulse transformer replacement
- Computer peripheral interface

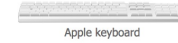

Features

Item	Parameter
Switching Speed	1M & 10M bit/s Max
High isolation	5000 VRMS
DC input with logic gate output	Yes
Operating temperature range	- 55 °C to 100 °C
MSL	Class 1



Selection Table							
Part number	Package	Status	Feature	V _{iso} (Vrms)	V _{cc} (V)	T _{PLH} /T _{PHL} (Max)	T _{OPR} (°C)
FSS-480P/W-T1V	LSOP6	MP	IPM, Positive output	5000	35	250ns	-55~110
FSS-481P/W-T1V	LSOP6	MP	IPM, Negative output	5000	35	250ns	-55~110
FSS-611P/W-T1V	LSOP6	MP	10M	5000	3.3/5	75ns	-40~110
FSS-50LP/W-T1V	LSOP6	MP	1M	5000	3.3/5	75ns	-40~110

Cross Reference

High Speed				
Part number	Package	Feature	BROADCOM	TOSHIBA
FSS-480P/W-T1V	LSOP6	IPM, Positive output	ACPL-P480	TLP2710
FSS-481P/W-T1V	LSOP6	IPM, Negative output	ACPL-P481	TLP2710
FSS-611P/W-T1V	LSOP6	10M High Speed	ACPL-P483	TLP2748
FSS-50LP/W-T1V	LSOP6	1M High Speed	ACPL-W50L	TLP2719 (LF4)

FOXCONN

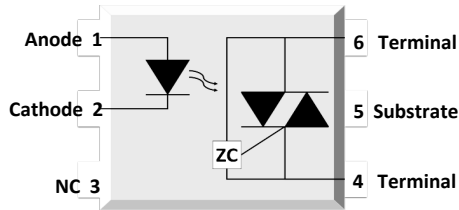
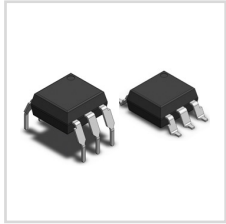

HALOGEN
FREE

RoHS
COMPLIANT



Applications



Solenoid / valve controls

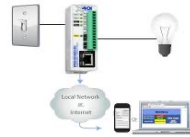

Lighting controls

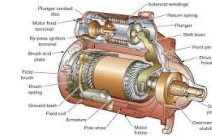

Motor controls



Temperature controls



Static AC power switches

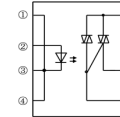

Solid state relays



Interfacing microprocessors to
115 to 240V AC peripherals

Features

Item	Parameter
High isolation	5000 VRMS
DC input with zero-cross / random-phase photo triac output	v
Operating temperature range	- 40 °C to 100 °C
REACH & RoHS compliance	v
MSL	Class 1
Safety approval	UL, VDE, and CQC



Selection Table							
Part number	Package	Status	Feature	V _{iso} (Vrms)	V _{cc} (V)	T _{PLH} /T _{PHL} (Max)	T _{OPR} (°C)
FSS-305XP/W-T1V	DIP6	MP	Z.C	5000	15,10,5	600	55~110
FSS-306XP/W-T1V	DIP6	MP	R.P	5000	15,10,5	600	55~110



Part number	Package	Applied voltage	Feature		ON-state current
S2S3A00F / S2S5A00F / S2S5FA0F	Mini-flat 4-pin	AC 200 V lines	200 V lines, compact		0.05 A
S2S4A00F	Mini-flat 4-pin	AC 200 V lines	200 V lines, compact	Built-in zero-cross circuit	0.1 A
PC3SH11YFZAH / PC3SH13YFZAH	DIP4	AC 200 V lines	Reinforced isolation		0.1 A
PC3SH21YFZBH	DIP4	AC 200 V lines	Reinforced isolation	Built-in zero-cross circuit	0.1 A
PC3SD12NTZAH / PC3SD11NTZBH / PC3SD11NTZCH	DIP4	AC 200 V lines	General purpose		0.1 A
PC3SD21NTZAH / PC3SD21NTZBH / PC3SD21NTZDH	DIP6	AC 200 V lines	Reinforced isolation	Built-in zero-cross circuit	0.1 A
PC3SF11YVZAH / PC3SF11YVZBH	DIP6	AC 200 V lines	Reinforced isolation		0.1 A
PC3SF21YVZAH / PC3SF21YVZBH	DIP6	AC 200 V lines	General purpose	Built-in zero-cross circuit	0.1 A
PC4SD11NTZCH	DIP6	AC 200 V lines	General purpose		0.1 A
PC4SD21NTZCH / PC4SD21NTZDH	DIP6	AC 200 V lines	Reinforced isolation	Built-in zero-cross circuit	0.1 A
PC4SF11YTZBH	DIP6	AC 200 V lines	Reinforced isolation		0.1 A
PC4SF21YVZBH / PC4SF21YWPSH	DIP6	AC 200 V lines		Built-in zero-cross circuit	0.1 A

SHARP

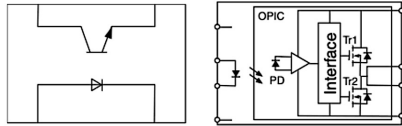

Applications



Programmable controller



Facsimiles



Telephones



Garage door opener



Process control

Features

Item	Parameter
Double transfer mold package	DIP4, DIP8
High collector-emitter voltage	VCEO : 80V
High isolation voltage between input and output	5 kV
Current transfer ratio	50%
Safety approval	UL, VDE, CQC

Selection Table

Part number	Package	Output type	Feature	
PC357NJ0000F / PC451J0000F	Mini-flat 4-pin	Single phototransistor	High collector-emitter voltage	
PC367NJ0000F	Mini-flat 4-pin	Darlington phototransistor	AC input response	Low input current
PC354NJ0000F	Mini-flat 4-pin	Darlington phototransistor	AC input response	
PC364NJ0000F	Mini-flat 4-pin	Darlington phototransistor	High sensitivity, High collector-emitter voltage	Low input current
PC355NJ0000F / PC452J0000F	Mini-flat 4-pin	Darlington phototransistor	High sensitivity, High collector-emitter voltage	
PC365NJ0000F	Mini-flat 4-pin	Single phototransistor	General purpose	Low input current
PC3H7J00001H	Compact half pitch	Single phototransistor	General purpose	
PC3HU7xYIP1B	Compact half pitch	Single phototransistor	AC input response	Reinforced insulation
PC3H71xNIP1H	Compact half pitch	Single phototransistor	AC input response	Low input current
PC3H3J00001H / PC3H4J00001H	Compact half pitch	Single phototransistor	AC input response	
PC123XxYSZ1B	DIP4	Single phototransistor	Reinforced insulation	
PC1231xNSZ1B	DIP4	Darlington phototransistor	High collector-emitter voltage	Low input current
PC817XxNSZ1B / PC851XNNSZ1H	DIP4	Darlington phototransistor	High collector-emitter voltage	
PC8171xNSZ1B	DIP4	Darlington phototransistor	High sensitivity, High collector-emitter voltage	Low input current
PC852XNNSZ1H	DIP4	Darlington phototransistor	High sensitivity, High collector-emitter voltage	



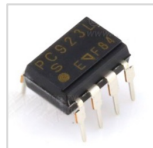

Selection Table				
Part number	Package	Output type	Feature	
PC400J00000F / PC410LENIP0F	Mini-flat 5-pin	Digital output	General purpose, High response speed	
PC457L0NIP0F	Mini-flat 5-pin	Analog/Digital output	High CMR	
PC923LRNSZ0F	DIP8	Built-in base amplifier	For inverter control	1.5A output
PC925LENSZ0F	DIP8	Built-in base amplifier	For inverter control	2.5A output

SHARP

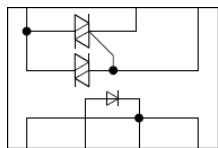
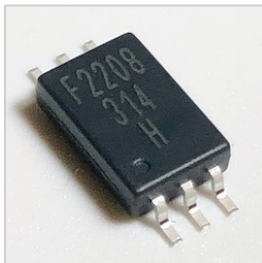

HALOGEN
FREE

RoHS
COMPLIANT



Applications



Heaters



Fans



Motors



White Goods

Features

Item	Parameter
Zero crossing functionary	VOX : MAX. 35V
High repetitive peak off-state voltage	VDRM : 400V ; 600V
High isolation voltage between input and output	Viso(rms) : 4.0kV
Superior noise immunity	dV/dt : MIN. 100V/μs
Safety approval:	UL, VDE, CQC



Selection Table					
Part number	Package	Applied voltage	Feature	ON-state current	
PR31MA11NTZH	DIP6	AC 200 V lines	General purpose	0.06 A	
PR32MA11NTZH	DIP6	AC 200 V lines	General purpose	0.15 A	
PR33MF5 series / PR36MF5 series / PR39MF5 series / PR3BMF5 series	DIP8	AC 200 V lines	General purpose	0.3 / 0.6 / 0.9 / 1.2 A	
PR36MF2 series / PR39MF2 series	DIP8	AC 200 V lines	Built-in zero-cross circuit	0.6 / 0.9 A	

Laser Diode

SHARP

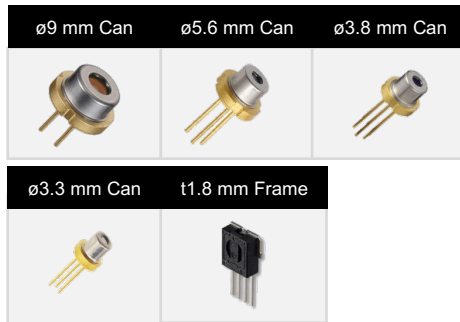
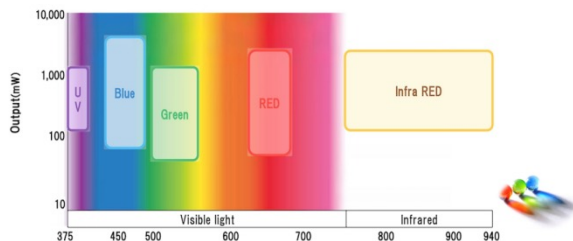

Applications

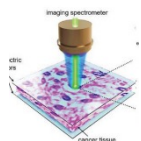

biologically relevant



Life Sciences related



Particle Counter



VR/AR

Features

Item-UV laser Diode	Parameter
Can Package	ø5.6 mm
Wavelength (nm)	395 nm ~ 406 nm
Absolute Maximum rating Po (mW)	1100 mW
Absolute Maximum rating Iop (mA)	650 mA
Item-Blue laser Diode	Parameter
Can Package	ø3.8 mm , ø5.6 mm , ø9 mm
Wavelength (nm)	435 nm ~ 487 nm
Absolute Maximum rating Po (mW)	2000 mW
Absolute Maximum rating Iop (mA)	4300 mA

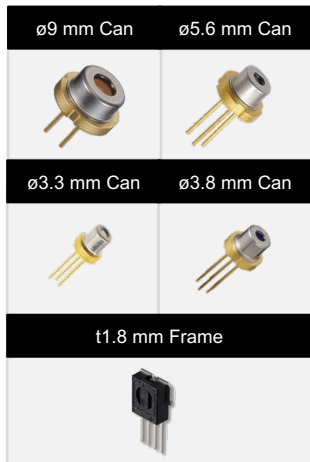

Selection Table

Color	Part No.	Wavelength (Peak) λp (nm)	Absolute maximum rating*1 Po (mW)	Absolute maximum rating*1 Iop (mA)	Absolute maximum rating*1 Top (C)	Po (mW)	Ith (mA)	Iop (mA)	Vop (V)	ηd (mW/mA)	λp (nm)	Θ// (°)	Θ⊥ (°)	FFP	Packaging	Monitor PD (Built-in: O)
UV	GH0393AA2G	395	350	-	0 to +30	300	150	310	4.4	1.8	395	13	44	*3	ø5.6	-
UV	GH0401FA2G	405	155	-	-10 to +75	150	40	130	5	1.7	405	9	19	*2	ø5.6	-
UV	GH0401FA2K	405	155	-	-10 to +75	150	40	130	5	1.7	405	9	19	*2	ø5.6	O
UV	GH04W10A2GC	406	350	-	0 to +50	300	140	325	4.5	1.8	406	14	41	*3	ø5.6	-
UV	GH0406AA2G	405	700	-	0 to +30	600	120	420	4.4	2	405	16	38	*3	ø5.6	-
UV	GH04V01A2G	405	1100	-	0 to +30	1000	125	625	5	2	405	16	40	*3	ø5.6	-
Blue	GH04C05W9G	435	-	3600	0 to +45	5000	350	3100	4.5	1.8	435	9	47	*3	ø9.0	-
Blue	GH04C05W9G	435	-	3000	45 to +60	5000	350	3100	4.5	1.8	435	9	47	*3	ø9.0	-
Blue	GH04C05V9G	440	-	3500	0 to +35	5000	350	3100	4.6	1.9	440	10	47	*3	ø9.0	-
Blue	GH04C03Z9G	450	-	2800	0 to +60	3500	260	2100	4.4	1.85	450	9	47	*3	ø9.0	-
Blue	GH04C06X9G	450	-	4300	0 to +60	6000	300	4000	4.8	1.55	450	9	48	*3	ø9.0	-
Blue	GH04580A2G	450	85	-	-10 to +70	80	22	84	5.1	1.3	450	10	24	*2	ø5.6	-
Blue	GH04C01A2G	450	1650	-	-10 to +50	1600	200	1200	5	1.5	450	6.5	23	*2	ø5.6	-
Blue	GH04C01B2G	450	2000	-	-10 to +50	1800	110	1100	4.1	1.8	450	7	26	*2	ø5.6	-
Blue	GH04590A5G	450	95	-	-10 to +50	90	28	100	5.2	1.3	450	9	24	*2	ø3.8	-
Blue	GH04850B2G	487	55	-	-10 to +60	50	40	105	6	0.8	487	8	23	*2	ø5.6	-

SHARP

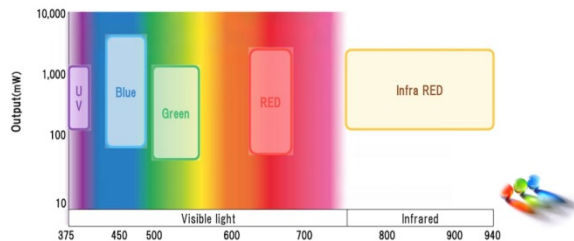

Applications



Robotic pool cleaner



Projector



Laser Distance Meter



Measuring Device



Life Sciences related

Features

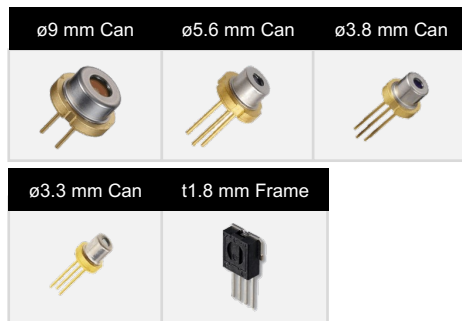

Item-Green laser Diode

Can Package

Wavelength (nm)

Absolute Maximum rating Po (mW)

Absolute Maximum rating Iop (mA)

Item-Red laser Diode

Can Package

Wavelength (nm)

Absolute Maximum rating Po (mW)

Absolute Maximum rating Iop (mA)

Parameter

ø3.8 mm , ø5.6 mm, ø9 mm, t1.8 mm

515 nm ~ 520 nm

135 mW

1650 mA

Parameter

ø3.3 mm , ø3.8 mm, ø5.6 mm, ø9 mm, t1.8 mm

638 nm ~ 660nm

1210 mW

1600 mA

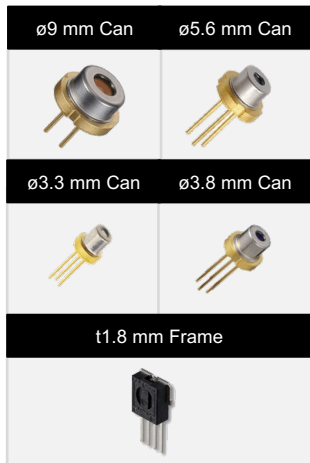

Selection Table

Color	Part No.	Wavelength(Peak)λp(nm)	Absolute maximum rating*1 Po(mW)	Absolute maximum rating*1 Iop(mA)	Absolute maximum rating*1 Top(C)	Po(mW)	Ith(mA)	Iop(mA)	Vop(V)	ηd(mW/mA)	λp(nm)	Θ//(°)	Θ⊥(°)	FFP	Packaging	Monitor PD (Built-in:O)
Green	GH15230H8C	515	35	-	-10 to +60	30	30	90	7	0.5	515	7.5	22	*2	t1.8	-
Green	GH05230H2KC	520	35	-	-10 to +60	30	25	70	6.5	0.65	520	7	22	*2	ø5.6	O
Green	GH05250F2K	520	55	-	-10 to +60	50	40	100	5.9	0.7	520	7	22	*2	ø5.6	O
Green	GH05280E2KC	520	85	-	-10 to +60	80	50	150	6.5	0.8	520	7	23	*2	ø5.6	O
Green	GH05280E5K	520	85	-	-10 to +60	80	65	180	6.5	0.7	520	7	23	*2	ø3.8	O
Green	GH0521DE2G	520	135	-	-10 to +60	130	70	270	6.7	0.65	520	8	22	*2	ø5.6	-
Green	GH05290A5G	520	95	-	-10 to +50	90	60	185	6.75	0.7	520	7	23	*2	ø3.8	-
Green	GH0521DE5G	520	135	-	-10 to +50	130	70	270	6.7	0.65	520	8	22	*2	ø3.8	-
Green	GH0523AD2G	520	-	850	0 to +60	300	100	500	5.2	0.75	520	7	23	*2	ø5.6	-
Green	GH05C01A9G	520	-	1400	0 to +60	600	180	1050	5.2	0.7	520	9	44	*3	ø9.0	-
Green	GH05C01C9G	520	-	2000	0 to +60	1000	250	1650	5.2	0.7	520	9	45	*3	ø9.0	-

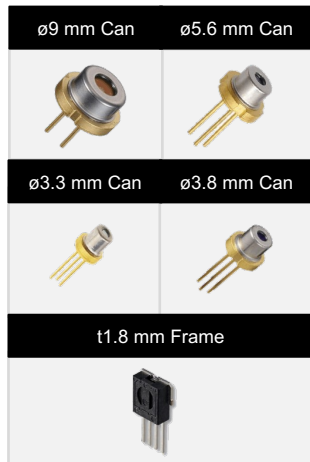

Selection Table

Color	Part No.	Wavelength(Peak) λ_p (nm)	Absolute maximum rating*1 Po(mW)	Absolute maximum rating*1 Iop(mA)	Absolute maximum rating*1 Top(C)	Po(mW)	Ith(mA)	Iop(mA)	Vop(V)	η_d (mW/mA)	λ_p (nm)	$\Theta_{//}$ (°)	Θ_{\perp} (°)	FFP	Packaging	Monitor PD (Built-in:O)
Red	GH06C01A9G	640	1210	1600	0 to +45	1200	350	1400	2.25	1.15	640	11	35	*2	ø9.0	-
Red	GH06C02B9G	640	-	(tbd)	0 to +55	2500	600	2800	2.4	1.1	639	15	70	*3	ø9.0	-
Red	GH06330A2G	638	30	-	-10 to +60	30	30	50	2.3	1.4	638	7	16	*2	ø5.6	-
Red	GH06311A2GC	638	185	-	-10 to +60	180	70	215	2.55	1.15	638	8	13	*2	ø5.6	-
Red	GH0632BA2GC	638	210	-	-10 to +60	200	55	230	2.65	1.15	639	8	15	*2	ø5.6	-
Red	GH0637AA2G	638	702	-	-10 to +40	700	110	810	2.46	1	638	16	35	*2	ø5.6	-
Red	GH0631CA5GC	638	120	-	-10 to +60	120	50	150	2.5	1.2	638	8	15	*2	ø3.8	-
Red	GH06311A5G	638	185	-	-10 to +60	150	60	190	2.5	1.15	638	7.5	15	*2	ø3.8	-
Red	GH1631AA8C	638	100	-	-10 to +60	100	50	130	2.45	1.2	638	8	15	*2	t1.8	-
Red	GH0652CA2GC	650	220	-	-10 to +70	200	55	220	2.6	1.2	650	8	12.5	*2	ø5.6	-
Red	GH06610A2KC	660	12	-	-40 to +90	10	15	24	2.2	1.1	660	12	33	*2	ø5.6	O
Red	GH06P25A2CC	660	100	-	-10 to +70	95	40	122	2.4	1.1	660	10	15.5	*2	ø5.6	-
Red	GH06510F4A	660	10	-	-10 to +70	7	17	26	2.2	0.85	660	13	28	*2	ø3.3	O
Red	GH16P32B8C	660	100	-	-10 to +70	90	42	120	2.3	1.16	661	9.3	15	*2	t1.8	-

SHARP

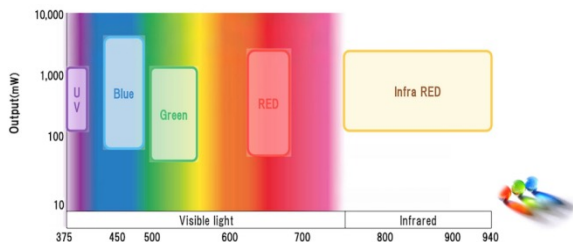

Applications

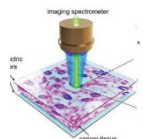

biologically relevant



Life Sciences related



Range Finder

Features

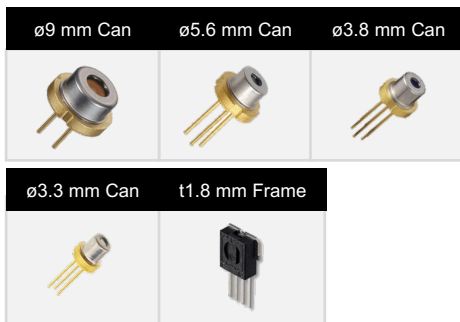

Item-IR laser Diode	Parameter
Can Package	ø3.3 mm , ø5.6 mm
Wavelength (nm)	785 nm ~ 940 nm
Absolute Maximum rating Po (mW)	260 mW
Absolute Maximum rating Iop (mA)	300 mA





Selection Table

Color	Part No.	Wavelength(Peak) λ_p (nm)	Absolute maximum rating*1 Po(mW)	Absolute maximum rating*1 Iop(mA)	Absolute maximum rating*1 Top(C)	Po(mW)	Ith(mA)	Iop(mA)	Vop(V)	η_d (mW/mA)	λ_p (nm)	$\theta_{//}$ (°)	θ_{\perp} (°)	FFP	Packaging	Monitor PD (Built-in:O)
IR	GH07P28F4C	785	150	-	-10 to +70	100	35	135	2.4	1	784	8	16	*2	ø3.3	-
IR	GH0832BA2K	830	210	-	-10 to +70	200	35	215	2.1	1.1	830	9	16	*2	ø5.6	O
IR	GH0832FA2G	830	260	-	-10 to +70	250	48	260	2.2	1.15	830	8	13.5	*2	ø5.6	-
IR	GH0852WA2G	850	700	-	-10 to +70	700	230	900	2	1	850	13.5	45	*3	ø5.6	-
IR	GH0942FA2G	940	260	-	-10 to +70	250	45	300	2.4	0.97	940	8	14	*2	ø5.6	-
IR	GH0942WA2G	940	700	-	-10 to +70	700	200	1000	2	0.9	940	15	45	*3	ø5.6	-

MEMS Microphones

Solid State System

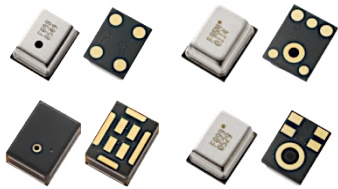

Product Consistency ↑

SNR Tolerance $\sim \pm 0.25$ dB

Automotive

Work in high temperature environment



RoHS COMPLIANT



Applications



Mobile Phone



Notebooks



Headphones / TWS



TV



Security



Automotive

Features

Item	Parameter
Own IC	YES
Own IP	YES
Has ANC	YES
Support High Pressure	YES
Low Power Consumption	YES
Our Own Rnd, Supports Customization	YES
Different Sensor Types + Different ASI Types	YES

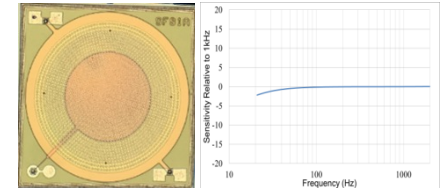

flat frequency response →
ANC headset 、 speech recognition

Solid State System



3SM227KMT1KA-P

Product Consistency ↑ SNR Tolerance $\sim \pm 0.25$ dB

Automotive Work in high temperature environment



Applications

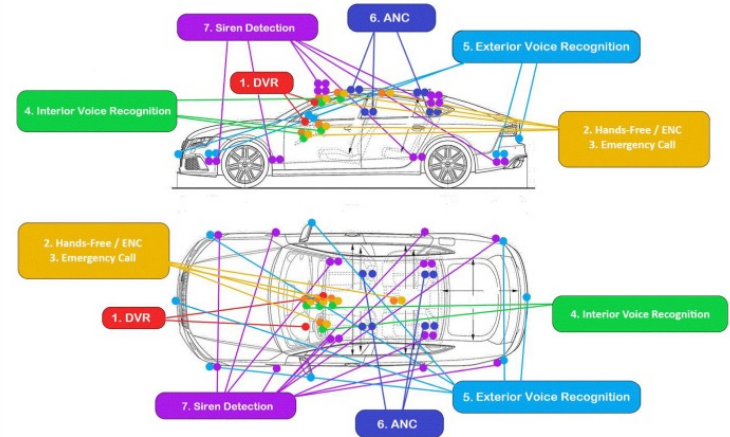

Features

Item	Parameter
Port	TOP
A/D	Digital
SNR	64 dB
AOP	120 dB
Sensitivity	-26 ± 1 dBFS
Package	4.00 x 3.00 x 1.00mm
PN	3SM227KMT1KA-P



Selection Table

P/N	A/D	SNR	AOP	Sensitivity	LFRO	Package	Port
3SM127E4T1UB	Analog	59 dB	130 dB	-42±1 dBV	130 Hz	3.76 x 2.95 x 1.10mm	Top
3SM127F4T1UE	Analog	60 dB	130 dB	-42±1 dBV	<20 Hz	3.76 x 2.95 x 1.10mm	Top
3SM127MZT1UA	Analog	66 dB	130 dB	-38±1 dBV	<20 Hz	3.76 x 2.95 x 1.10mm	Top
3SM127MZB1UA	Analog	66 dB	130 dB	-38±1 dBV	<20 Hz	3.76 x 3.00 x 1.10mm	Bottom
3SM127LZB1HA	Analog	65 dB	130 dB	-38±1 dBV	<20 Hz	3.50 x 2.65 x 0.98mm	Bottom
3SM227KMT1KA-P	Digital	64 dB	120 dB	-26±1 dBFS	50 Hz	4.00 x 3.00 x 1.00mm	Top
3SM227KMB1HA-P	Digital	64 dB	120 dB	-26±1 dBFS	50 Hz	3.50 x 2.65 x 0.98mm	Bottom
3SM127E4T1UB	Analog	59 dB	130 dB	-42±1 dBV	130 Hz	3.76 x 2.95 x 1.10mm	Top
3SM127F4T1UE	Analog	60 dB	130 dB	-42±1 dBV	<20 Hz	3.76 x 2.95 x 1.10mm	Top
3SM127MZT1UA	Analog	66 dB	130 dB	-38±1 dBV	<20 Hz	3.76 x 2.95 x 1.10mm	Top
3SM127MZB1UA	Analog	66 dB	130 dB	-38±1 dBV	<20 Hz	3.76 x 3.00 x 1.10mm	Bottom

- ❖ AEC-Q100 is Verification specification for active components
- ❖ AEC-Q103 is Verification specification for MEMS microphones



Selection Table

P/N	A/D	SNR	AOP	Sensitivity	LFRO	Package	Port
3SM121JZB1VB-R	Analog	63 dB	128 dB	-38±1 dBV	<20 Hz	2.75 x 1.85 x 0.90mm	Bottom
3SM123B4T1VA-R	Analog	56 dB	130 dB	-42±1 dBV	26 Hz	2.75 x 1.85 x 0.95mm	Top
3SM123C4T1VA-R	Analog	57 dB	123 dB	-42±1 dBV	63 Hz	2.75 x 1.85 x 0.95mm	Top
3SM122HZB1VD-R	Analog	62 dB	123 dB	-38±1 dBV	30 Hz	2.75 x 1.85 x 0.90mm	Bottom
3SM123GZB1VD-R	Analog	61.5 dB	123 dB	-38±1 dBV	20 Hz	2.75 x 1.85 x 0.90mm	Bottom
3SM123B4T1VA-R	Analog	56 dB	130 dB	-42±1 dBV	26 Hz	2.75 x 1.85 x 0.95mm	Top
3SM123C4T1VA-R	Analog	57 dB	123 dB	-42±1 dBV	63 Hz	2.75 x 1.85 x 0.95mm	Top
3SM122HZB1VD-R	Analog	62 dB	123 dB	-38±1 dBV	30 Hz	2.75 x 1.85 x 0.90mm	Bottom
3SM122KZB1VD-002-R	Analog	64 dB	128 dB	-38±1 dBV	<20 Hz	2.75 x 1.85 x 0.90mm	Bottom
3SM222FMT1WA	Digital	60 dB	120 dB	-26±1 dBFS	38 Hz	3.10 x 2.50 x 0.90mm	Top
3SM222HMB1WA	Digital	62 dB	120 dB	-26±1 dBFS	<20 Hz	3.10 x 2.50 x 0.85mm	Bottom
3SM222HMB1HA-002	Digital	62 dB	120 dB	-26±1 dBFS	<20 Hz	3.50 x 2.65 x 0.98mm	Bottom



Selection Table

P/N	A/D	SNR	AOP	Sensitivity	LFRO	Package	Port
3SM126KZT1VA-002-R	Analog	64 dB	<20 Hz	-38±1 dBV	128 Hz	2.75 x 1.85 x 1.05mm	Top
3SM126KZB1VD-002-R	Analog	64 dB	<20 Hz	-38±1 dBV	128 Hz	2.75 x 1.85 x 0.90mm	Bottom
3SM121MZT1UA	Analog	66 dB	130 dB	-38±1 dBV	<20 Hz	3.76 x 2.95 x 1.10mm	Top
3SM121MZB1UA	Analog	66 dB	130 dB	-38±1 dBV	<20 Hz	3.76 x 3.00 x 1.10mm	Bottom
3SM121LZB1HA	Analog	65 dB	130 dB	-38±1 dBV	<20 Hz	3.50 x 2.65 x 0.98mm	Bottom
3SM221KMT1KA-P	Digital	64 dB	120 dB	-26±1 dBFS	50 Hz	4.00 x 3.00 x 1.00mm	Top
3SM221KMT1KA-P	Digital	64 dB	120 dB	-26±1 dBFS	50 Hz	4.00 x 3.00 x 1.00mm	Top
3SM221KMT1GA-P	Digital	64 dB	120 dB	-26±1 dBFS	100 Hz	4.00 x 2.00 x 1.10mm	Top
3SM222KMB1HA-P	Digital	64 dB	120 dB	-26±1 dBFS	50 Hz	3.50 x 2.65 x 0.98mm	Bottom
3SM221KMT1KA-P	Digital	64 dB	120 dB	-26±1 dBFS	50 Hz	4.00 x 3.00 x 1.00mm	Top
3SM123C4T1VA	Analog	57 dB	123 dB	-42±1 dBV	63 Hz	2.75 x 1.85 x 0.95mm	Top
3SM123GZB1VD	Analog	61.5 dB	123 dB	-38±1 dBV	20 Hz	2.75 x 1.85 x 0.90mm	Bottom



Selection Table

P/N	A/D	SNR	AOP	Sensitivity	LFRO	Package	Port
3SM123C4T1VA-022	Analog	57dB	123 dB	-42±1 dBV	63 Hz	2.75 x 1.85 x 0.90mm	Top
3SM123GZB1VE-021	Analog	61.5 dB	130 dB	-38±1 dBV	20 Hz	2.75 x 1.85 x 0.90mm	Bottom
3SM221KMT1KA	Digital	64 dB	120 dB	-26±1 dBFS	50 Hz	4.00 x 3.00 x 1.00mm	Top
3SM222KMB1HA	Digital	64 dB	120 dB	-26±1 dBFS	50 Hz	3.50 x 2.65 x 0.98mm	Bottom
3SM221KMT1KC-P	Digital	64 dB	120 dB	-26±1 dBFS	24 Hz	4.00 x 3.00 x 1.00mm	Top
3SM221KMT1GC-P	Digital	64 dB	120 dB	-26±1 dBFS	50 Hz	4.00 x 2.00 x 1.10mm	Top
3SM123GZB1VD	Analog	61.5 dB	123 dB	-38±1 dBV	20 Hz	2.75 x 1.85 x 0.90mm	Bottom
3SM222KMB1HC-P	Digital	64 dB	120 dB	-26±1 dBFS	30 Hz	3.50 x 2.65 x 0.98mm	Bottom
3SM222KMB1HC-P	Digital	64 dB	120 dB	-26±1 dBFS	30 Hz	3.50 x 2.65 x 0.98mm	Bottom
3SM221KMT1KC-P	Digital	64 dB	120 dB	-26±1 dBFS	24 Hz	4.00 x 3.00 x 1.00mm	Top
3SM221KMT1GC-P	Digital	64 dB	120 dB	-26±1 dBFS	50 Hz	4.00 x 2.00 x 1.10mm	Top
3SM121KZB1HC	Analog	64 dB	120 dB	-38±1 dBV	30 Hz	3.50 x 2.65 x 0.98mm	Bottom

Sensor

FOXCONN SHARP

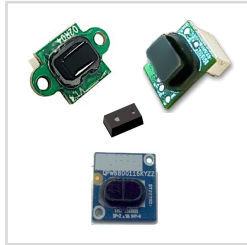

Applications



Cleaning robot



Smart toilet



Attendance machine



Automatic Tap



Capacity detection

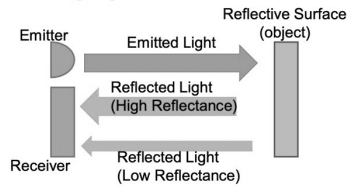

Improved ambient light removal

Features

Part Number	Rang distance	VCSEL peak wavelength	Power supply voltage	Operating temperature	Product type
GP2AP02VT20F	10 ~ 120 cm	940 nm	3.3 V	- 20 ~ 70 °C	Sensor
GP2AP03VT00F	0 ~ 10 cm	940 nm	3.3 V	- 20 ~ 70 °C	Sensor
FSB-004-001AN02	0 ~ 10 cm	940 nm	3.3 V	- 20 ~ 70 °C	Module
FSB-020-001AN06	5 ~ 200 cm	940 nm	3.3 V	- 20 ~ 70 °C	Module
FSB-050-001AN03	5 ~ 500 cm	940 nm	3.3 V	- 20 ~ 70 °C	Module



SHARP



Triangulation method

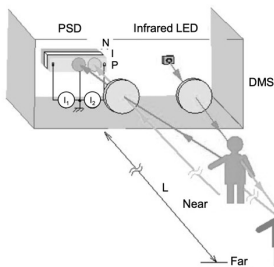

HALOGEN FREE

RoHS COMPLIANT



Applications



Cleaning robot



Smart toilet



Attendance machine



Automatic Tap



Projector



Robot



AGV

Features

Item	Parameter
Type	Standard / Compact / Hi-accuracy CMOS
Output type	Analog / I2C / Both / 1bit Hi or Low digital

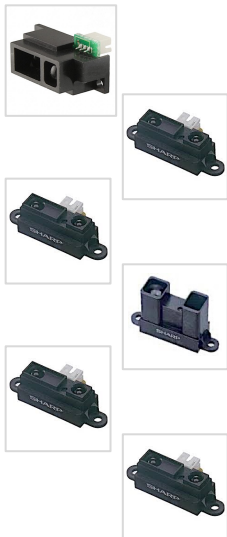

Selection Table			
P/N	Measuring range	Size	Output type
GP2Y0A51SK0F	2 ~ 15 cm	27×10.8×12t mm	Analog
GP2Y0A41SK0F	4 ~ 30 cm	29.5×18.9×13.5t mm	Analog
GP2Y0A21YK0F	10 ~ 80 cm	29.5×18.9×13.5t mm	Analog
GP2Y0A02YK0F	20 ~ 150 cm	29.5×18.9×21.6t mm	Analog
GP2Y0D21YK0F	24 cm	29.5×18.9×13.5t mm	1bit Hi/Low digital
GP2Y0D02YK0F	80 cm	29.5×18.9×21.6t mm	1bit Hi/Low digital



Selection Table					
P/N	Measuring range	Size	Average Consumption Current	Distance Measuring Cycle	Output type
GP2Y0AF15*	1.5 ~ 15 cm	21.2×8.5×6.3t mm	Typ. 17 mA	Typ. 16.5 ms	Analog
GP2Y0AF30*	4 ~ 30 cm	20×8.5×9.0t mm	Typ. 17 mA	Typ. 16.5 ms	Analog

Hi-accuracy CMOS

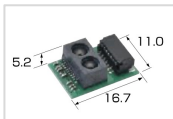
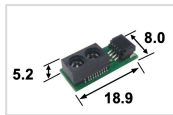

Selection Table						
P/N	Measuring range	Size	Current consumption	Measuring time	Accuracy at 50 cm, 25 °C	Output type
GP2Y0E02A	4 ~ 50 cm	18.9×8×5.2t mm	26 mA	Max.40 ms	± 10%	Analog
GP2Y0E02B	4 ~ 50 cm	18.9×8×5.2t mm	26 mA	Max.40 ms	± 10%	I2C
GP2Y0E03	4 ~ 50 cm	16.7×11×5.2t mm	26 mA	Max.40 ms	± 10%	Analog / I2C

SHARP

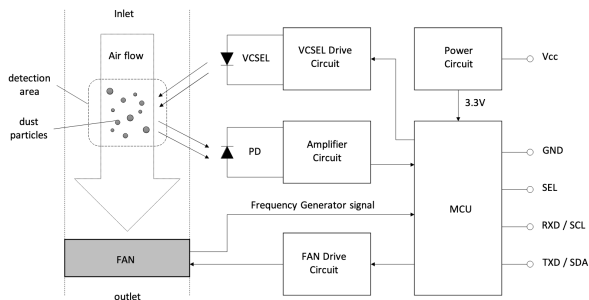

Applications



Air conditioner



Air purifier

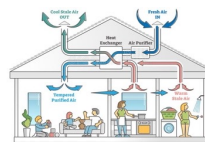

Ventilation system



Air quality monitor



Consumer electronic products

Features

Item	Parameter
Size	46×34×12mm
Output interface	UART / I2C
Detectable	PM1.0 / PM2.5 / PM10 separately
Operating supply voltage	5 ± 0.25 V
Power consumption	Typ 200mW
Sensitivity	±10%(@PM1.0)
Operating temp.	-10 to 65 °C
Storage temp.	Correction by microcomputer
Equipped with auto cleaning mode function	Yes

Selection Table

P/N	Sensing system	Minimum dust size	Sensing range(TYP) (PM2.5)	Sensitivity accuracy	Output interface	Sensing of each dust size
GP2Y1040AU0F	Particle count	0.3 μ m	~ 500ug/m3	\pm 10%	UART / I2C	(1.0 / 2.5 / 10)
GP2Y1026AU0F	Average density	0.5 μ m	~ 1000ug/m3	\pm 15%	Serial data (UART)	No
GP2Y1014AU0F	Average density	0.5 μ m	~ 580ug/m3	0.5V \pm 15%	Analog voltage	No



SHARP



Applications



DLP Project



Lens



Robot



Water meter



Printer

Features

OPIC output type 【GP1A173LCS5F】

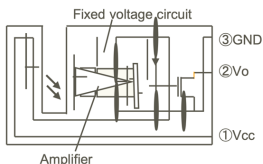
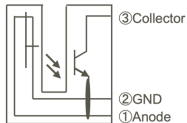

Photo transistor output type 【GP1S173LCS2F】



HALOGEN FREE

RoHS COMPLIANT



Item	Parameter
High operating temperature	-30 to +95°C
Extending area to use photointerrupter under High/Low temperature condition in copier & LBP.	Yes
High reliability of connection improved by combined case & connector as one part.	Yes
Low supply current max. 16.5mA by OPIC output type	GP1A173LCS5F

Photointerrupter - Transmissive Type [Compact type]

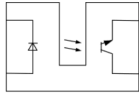

Selection Table				
Model No.	Features	Size	Detecting and Emitting gap (mm)	Slit width (mm)
GP1S092HCPIF	Wide gap, for soldering reflow, surface mount compatible, with positioning boss	4.5 × 2.6 × 2.9 [height] mm	2.0	0.3
GP1S093HCZ0F	Wide gap	4.5 × 2.6 × 2.9 [height] mm	2.0	0.3
GP1S094HCZ0F	Wide gap, with positioning pin	5.5 × 2.6 × 4.8 [height] mm	3.0	0.3
GP1S097HCZ0F	Wide gap, with mounting hole	4.5 × 2.6 × 4.5 [height] mm	2.0	0.3
GP1S194HCZ0F	Compact, wide gap,	3.6 × 2.0 × 2.7 (height) mm	1.7	0.3
GP1S195HCPSF	Compact, wide gap, surface mount compatible	3.4 × 2.0 × 2.7 (height) mm	1.5	0.3
GP1S196HCZ0F	Compact, low profile	3.1 × 2.0 × 2.7 [height] mm	1.1	0.3
GP1S196HCPSF	Surface mount, for soldering reflow, compact, low profile	3.1 × 2.0 × 2.7 [height] mm	1.1	0.3
GP1S296HCPSF	Surface mount, for soldering reflow, compact, low profile	2.5 × 1.8 × 1.9 [height] mm	1.0	0.2
GP1S396HCP0F	Straight lead type, compact, low profile	2.26 × 1.4 × 1.6 [height]mm	1.2	0.12
GP1S396HCPSF	Surface mount, for soldering reflow, compact, low profile	2.26 × 1.4 × 1.6 [height] mm	1.2	0.12

Photointerrupter - Transmissive Type [With connect]

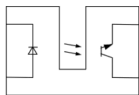

Selection Table			
Model No.	Features	Detecting and Emitting gap (mm)	Slit width (mm)
GP1S173LCS2F	High resolution, both-side mounting type	3.0	0.5

OPIC Type

“OPIC” (Optical IC) is a trademark of SHARP Corporation. An OPIC consists of a light-detecting element and signal-processing circuit integrated onto a single chip.



Model No.	Features	Detecting and Emitting gap (mm)	Slit width (mm)
GP1A173LCS5F	Snap-in mounting integrated connector type *1 3.3 V / 5 V operation enforced electrostatic discharge (ESD) increased power line noise tolerance	5.0	0.5

Photointerrupter - Transmissive Type [Case type OPIC]

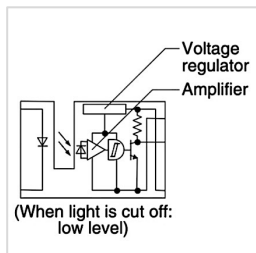

“OPIC” (Optical IC) is a trademark of SHARP Corporation. An OPIC consists of a light-detecting element and signal-processing circuit integrated onto a single chip.

Selection Table

Model No.	Features	Detecting and Emitting gap (mm)	Slit width (mm)
GP1A51HRJ00F	Side mounting, with screw hole	3.0	0.5
GP1A57HRJ00F	PWB mounting type, with positioning pin	10.0	1.8

SHARP



GP2A430LCS0F

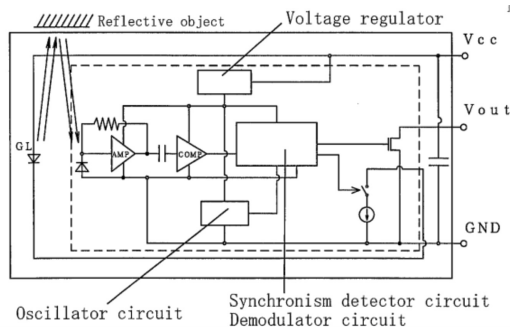

Applications



DLP Project



Lens



Robot



Water meter



Printer

Features

Item	Parameter
Wide operation voltage.	$V_{cc} = 3.0 \sim 5.5V$
Low current dissipation	$I_{cc} = \text{max. } 10mA$
High resistant to line noise.	$V_{p-p} \geq 4.0V$
Strong for detecting skewed paper	$\theta \geq 55^\circ$
High sensitivity type that is resistant to black paper detection.	GP2A430LCS0F



Photointerrupter - Reflective Type [Compact type]

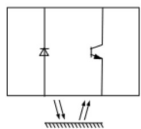

Selection Table

Model No.	Features	Size	Detecting and emitting Gap (mm)	Slit width (mm)
GP2S700HCP	Compact, long focal distance, surface mounting leadles	4 × 3 × 2 [height] mm	4	1.5
GP2S60	Thin, surface mounting leadless type	3.2 × 1.7 × 1.1 [height] mm	1	1.0

Photointerrupter - Reflective Type [Case type OPIC]

[Internal connection diagram]

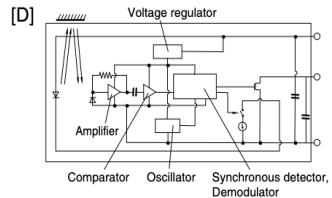
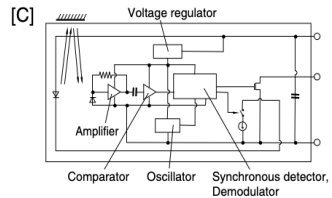
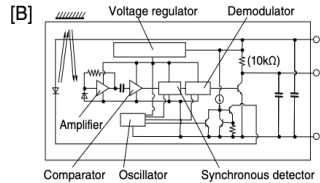
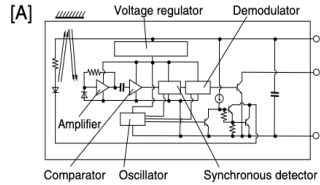

Selection Table				
Model No.	Features	Optimum detecting Distance (mm)	Internal connection diagram	
GP2A200LCS0	Multiple types of paper detectable, light modulation type, with connector, sensitivity adjusted	5 to 15	A	
GP2A240LCS0F	Applicable to inverter fluorescent lamp, light modulation type, with connector, sensitivity adjusted	5 to 15	A	
GP2A250LCS0F	Static electricity resistant, applicable to inverter fluorescent lamp, light modulation type, with connector, sensitivity adjusted	2.5 to 12.5	A	
GP2A451LCS0	Compact, screw-clamp type, Applicable to inverter fluorescent lamp, Light modulation type, with connector, 3.3 to 5.0V operation	2.5 to 12.5	D	
GP2A25J0000F	Multiple types of paper detectable, light modulation type, with connector, sensitivity adjusted	3 to 7	A	
GP2A432LCS0F	Compact, screw-clamp type, multiple types of paper detectable, light modulation type, with connector		B	
GP2A432LCSAF	Compact, hook type, multiple types of paper detectable, light modulation type, with connector		B	
GP2A430LCS0F	Compact, screw-clamp type, multiple types of paper detectable, light modulation type, with connector, 3.3 to 5V Operation, Low power consumption		C	
GP2A430LCSAF	Compact, hook type, multiple types of paper detectable, light modulation type, with connector, 3.3 to 5V Operation, Low power consumption		C	
GP2A431LCS	Multiple types of paper detectable, light modulation type, sensitivity adjusted, improved light-resistance characteristic for inverter lighting, built-in visible light cut filter		C	
GP2A25NJ00	Multiple types of paper detectable, light modulation type, with connector, sensitivity adjusted	A		
GP2A25DJ000F	Multiple types of paper detectable, light modulation type, with connector, sensitivity adjusted	A		
GP2A28AJ000F	Multiple types of paper detectable, light modulation type, with connector, sensitivity adjusted, hook type	A		

Sensor Product Application Coverage



Display
LCM / TP Module /
TP Controller



Fitness Gear
Rotate Sensing



Security Camera
CIS / Sensor



Mobile
Distance Ranging /
Proximity Sensing



**Cleaning Robot /
AGV**
Distance Ranging
Sensor



MFC
Paper Sensing
Rotate Sensing



Smart Storage
Distance Sensing



Robot
Position Sensing



Air Treatment
PM2.5 Sensor /
VOCs Sensor



Laser
Light Source



Smart Door
Distance Ranging /
Proximity Sensing



AR / VR
Distance Ranging /
Proximity Sensing



White Goods
Photo-product



**Bathroom
Equipment**
Proximity Sensing

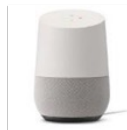

Smart Home
Distance Ranging /
Proximity Sensing



Earphone
Proximity Sensing



Wireless Modules

With a fresh approach to the radio frequency communication sector, we bring forth innovative wireless communication modules backed by cutting-edge chip design experience and robust technical support from leading semiconductor manufacturers. Our commitment lies in providing state-of-the-art system solutions, peripheral equipment, and audio-visual equipment, focusing on research and development, production, and sales to deliver excellence in connectivity.

Our product line includes the latest in wireless technology standards: IEEE802.11 a/b/g/n/ac/ax, Bluetooth, 4G, NB-IoT, PLC, UWB, millimeter wave, Sub1G, and Zigbee modules. Through our products, we strive to revolutionize the way devices connect and communicate, offering superior performance and reliability.

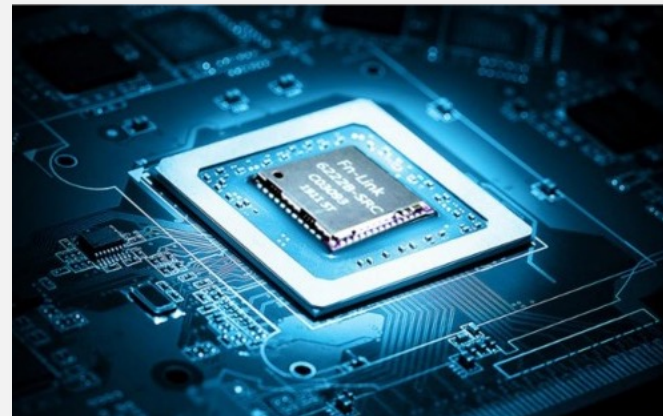



Excellent Customer Service:

Our commitment extends beyond delivering quality products; we offer flexible design customization for baseboards and I/O interfaces to meet the unique requirements of your applications. Our dedicated team provides comprehensive technical documentation support and assists with product certification processes, ensuring you have a seamless technical cooperation and support agreement with the original manufacturers, every step of the way in your product development journey.

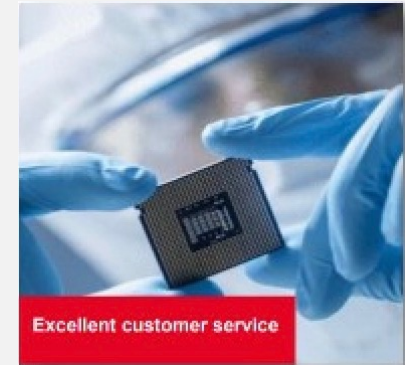

Consumer Electronics, Commercial equipment, Home appliances, Lighting, Medical devices, Smart city and other application.



Wi-Fi 4 (+BT) Wireless Module

IOT Module



Wi-Fi 4 (+BT) Wireless Module (REALTEK IC)

Model NO	FS-i5188 series	FS-i5189 series	FS-5223 series	FS-i5192 series
Main chip	RTL8188FTV-VQ1 RTL8188FTV-VC RTL8188FTV-VB RTL8188GTV/RTL8188ETV	RTL8189ES-VB RTL8189FTV-VQ1 RTL8189EM RTL8189FTV-VC	RTL8723DS RTL8723FS RTL8723DU	RTL8192FC RTL8192FS/CS
Wi-Fi Standard	Wi-Fi4 (802.11.b/g/n) 2.4GHz			
BT Standard	N/A	N/A	2.1+EDR/3.0/4.2/5.2	N/A
Bandwidth	HT20 HT20/HT40	HT20/HT40		
Antenna	1T1R			2T2R
Interface Wi-Fi/BT	USB2.0	SDIO2.0	SDIO2.0/UART USB2.0/PCM	USB2.0 SDIO3.0
Throughput	72.2Mbps 150Mbps	150Mbps		300Mbps

IOT Module



Wi-Fi 5

Wi-Fi 5 (+BT) Wireless Module (REALTEK IC)

Model NO	FS-i5811series	FS-i5821 series	FS-5822 series
main chip	RTL8811CU	RTL8821AU RTL8821CE RTL8821CU-VB-CG RTL8821CS RTL8821CSH	RTL8822BS RTL8822CS-VS-CG
Wi-Fi Standard	Wi-Fi5 (802.11.b/g/n/ac) 2.4GHz / 5GHz		
BT Standard	N/A	2.1+EDR/3.0/4.2/5.0	
Bandwidth	HT20/HT40/HT80		
Antenna	1T1R		2T2R
Interface Wi-Fi/BT	USB2.0	USB/USB2.0 PCIe/USB USB3.0/UART	SDIO3.0/UART PCIe/UART PCI/USB
Throughput	433Mbps		866Mbps

IOT Module



WiFi 6

Wi-Fi 6 (+BT) Wireless Module (REALTEK IC)

Model NO	FS-I5852 series		
main chip	RTL8852BE-VR / RTL8852BS / RTL8852BE-CG / RTL8852BU / RTL8852BS		
Wi-Fi Standard	Wi-Fi6 (802.11.b/g/n/ac/ax) 2.4GHz / 5GHz		
BT Standard	2.1+EDR/3.0/4.2/5.2		
Bandwidth	HT20/HT40/HT80	HT20/HT40/HT80	HT20/HT40/HT80
Antenna	2T2R		
Interface Wi-Fi/BT	SDIO3.0/UART PCIe/UART PCIe/USB USB/USB3		
Throughput	1200Mbps		

IOT Solution



IOT DK Wireless Module

Model NO	FS-i5210 series	FS-i5220 series	FS-i5262 series
main chip	RTL8715AH/RTL8710CX/RTL8711AM	RTL8720CF-VA2-CG/RTL8722DM	RTL8762CMF
Wi-Fi Standard	Wi-Fi4 (802.11.b/g/n) 2.4GHz		N/A
BT Standard	N/A	BLE4.2 1Mbps BLE5.0 2Mbps	BLE5.0-MESH
Bandwidth	HT20/HT40/HT80	HT20/HT40/HT80	HT20/HT40/HT80
Antenna	1T1R		single
Interface Wi-Fi/BT	SDIO/Uart/GPIO/I2C/PWM	SPI/Uart/GPIO/I2C/PWM/USB/SDIO	UART/GPIO/I2C/PWM
Throughput	150Mbps		2Mbps

IOT Module



NB IOT + Wi-Fi + BLE Module

Model NO	FS-i5518 series	FS-i5519 series	FS-i5520 series
main chip	RTL9518AM-II2	RTL9518AM-IIM	RTL9518AQM-II2
NB-IoT	NB ver.R13/R14/R15 (s/w upgrade) Peak Data rate (@NB2; Multi-tone; 2HARQ) DL 126.8 kbps UL 158.5 kbps 700MHz-2.1GHz(Supporting US B103 defined in 3GPP R17)		
Wi-Fi Standard	Wi-Fi4 (802.11.b/g/n) 2.4GHz		N/A
BT Standard	BLE5.0-MESH		
Bandwidth	HT20/HT40/HT80		
Antenna	1T1R		1T1R
Interface Wi-Fi/BT	SDIO/Uart/GPIO/I2C/PWM	SPI/Uart/GPIO/I2C/PWM/USB/SDIO	UART/GPIO/I2C/PWM

IOT Module



Special specifications and prices for customized needs

Model NO	FS-i5008	FS-i5009-PUC	FS-i5106W-R	FS-i5110-C
main chip	BL602 (bouffalolab,cn)	RTL8720 (Realtek)	ASR1606C (asmicro,cn)	LE5010A1 (LinkedSemi,cn)
NB-IoT	N/A	N/A	LTE CATM1,FDDB1/3/5/8,GSM	N/A
Wi-Fi Standard	802.11.b/g/n		N/A	N/A
BT Standard	BLE5.0	BLE4.2	N/A	BLE5.0
Bandwidth	HT20/HT40	HT20/HT40	HT20/HT40	N/A
Antenna	1T1R	1T1R	1T1R	1T1R
Interface Wi-Fi/BT	SDIO/Uart/GPIO/I2C/PWM	PCI-e	SDIO/Uart/GPIO/I2C/PWM	SPI/Uart/GPIO/I2C/PWM/USB/S DIO
Remark	Low prices	Dedicated PCI-e interface	NB and mobile communications	only BLE5.0,Low prices

Worldwide Handler



(*) : Non-franchised

Local Agent Distributor (US, EU, CN, TW, ASEAN)



United we grow



Branded Business Partners



Panasonic



SIEMENS

MASCO



LIXIL



Hisense



PHILIPS



OTIS

TOTO

HITACHI



Haier

